

CATÁLOGO 2022

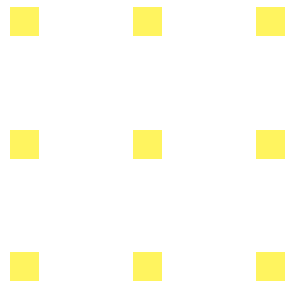

FERREMILIAN

HERRAJES PARA PUERTAS, MUEBLES
COCINAS Y ARMARIOS





HERRAJES PARA PUERTAS

5-87 **ALUMINIO Y ZAMAK**
100-101 ALUMINIUM & ZAMAK

Manivelas Door Handles
Manillones Pull Handles
Complementos Accessories



88-99 **LATÓN**
BRASS

Manivelas Door Handles
Manillones Pull Handles
Complementos Accessories



102-129 **INOX**
STAINLESS STEEL

Manivelas Door Handles
Manillones Pull Handles
Manillones para puertas de cristal Glass door pull handles
Complementos Accessories



130-171 **HERRAJES**
DOOR HARDWARE FITTINGS

Herrajes para puerta corredera Sliding Door Hardware
Pomos Door knobs
Mirillas Door viewers
Picaportes, cilindros y cerraduras Door latches, cylinders & mortise locks
Topes de puerta Door stoppers
Pernios de acero inoxidable Stainless steel hinges
Pernios Steel hinges
Bisagras Steel flat hinges
Pasadores de puerta Door bolts



172-179 **CABINAS SANITARIAS**
SANITARY CABINS



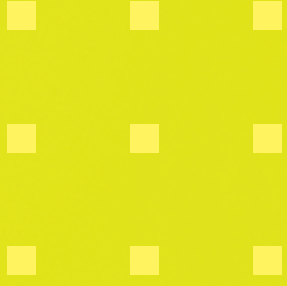

CODIFICACIONES CODE INDEX

Detallamos la interpretación del código de referencia de nuestras manivelas con placa o roseta, manillones y complementos para un mejor entendimiento. El resto de productos de este catálogo siguen una interpretación diferente a la que especificamos pero que guarda relación con el producto al que codifican.

Nuestras referencias constan de un código inicial de tres dígitos que determina el modelo, haciendo referencia el primero de los tres al material del producto. Le siguen dos dígitos que determinan el tipo de producto (manivela con roseta, manivela con roseta cuadrada, manillón con placa...) y los últimos dos dígitos nos indican el acabado del producto. Los códigos pueden sufrir variaciones. En el caso de los modelos de manivela con placa o roseta, el código del material sólo hace referencia a la manivela.

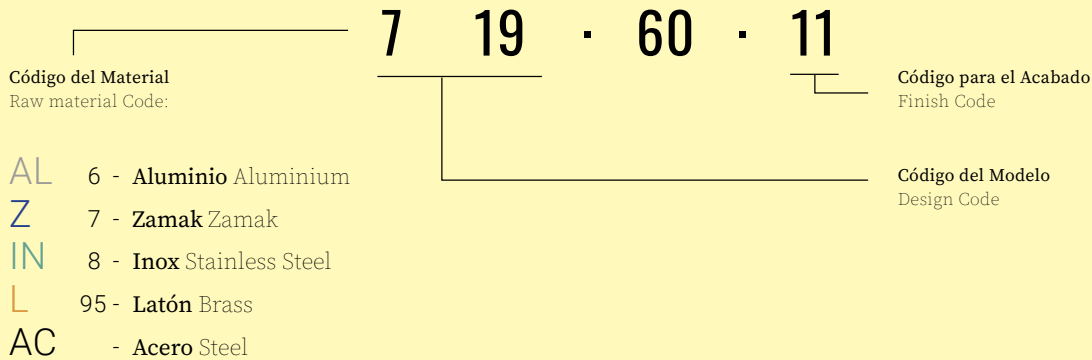

ACABADOS DISPONIBLES AVAILABLE FINISHES

NS 01 Níquel Satinado Satin Nickel	CS 06 Cuero Satinado Antique Brass	CRT 15 Cromo Brillo - Titanio Chromed Plated - Satin Black
IN 01 Inox Inox	N 07 Negro Black	T 15T Titanio Satin Black
SAT 02 Satinado Satin	PVD 08 Pvd Pvd	BM 23 Blanco Mate Matt White
BS 002 Brillo Satinado Satin Brass	ANTIC 09 Antic Antic	
PB 03 Pulido Brillo Polished Brass	NNS 11 Níquel Brillo - Níquel Satinado Plated Nickel - Satin Nickel	
CR 04 Cromo Brillo Chorme Plated	P 12 Perla Matt Satin Nickel	
CRS 05 Cromo Satinado Satin Chrome	B 13 Blanco White	
CRM 005 Cromo Mate Matt Chrome	CNS 14 Cromo Brillo - Níquel Satinado Chorme Plated - Satin Nickel	

* Mirillas, pernios y bisagras:
los códigos de referencia no guardan relación con esta tabla.

TIPOS DE BOCALLAVE KEYHOLE TYPES

Por favor indique en su pedido, si procede, tanto el tipo como la distancia entre centros de su bocallave.
Please indicate in your order, if applicable, keyhole type and distance between centers of the keyhole.

El coste de cada bocallave realizado sobre placas de Acero Inoxidable tendrá un sobrecoste de 0,60 € por juego.
El bocallave "F" y sus accesorios llevan un incremento de 1,30 € en el precio del juego.
Each keyhole made on stainless steel items, have an extra cost of 0,60 € per set.
Price increment for "F" keyhole and their accessories is 1,30 € per set.

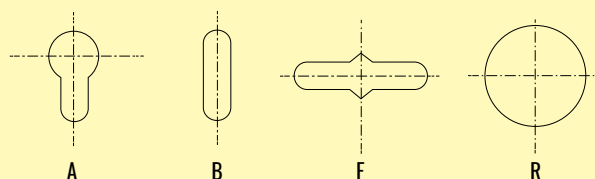

Cada medio juego de manivela pedido tendrá un sobrecoste de 1€ en concepto de manipulación.
In case your order includes any half set for handle on rose or plate, extra cost will be 1€ per each piece required.

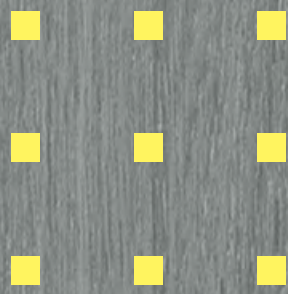

HERRAJES PARA PUERTAS



SERIE
ALYA 



Manivela con roseta
Door handle on rose

SERIE
ALYA

AL Aluminio Z Zamak
Aluminium Zamak

610.50 AL1.....20
710.50 Z1.....20

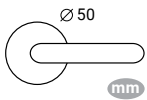

AL
Z

HERRAJES PARA PUERTAS



CRS 610.50.05



NS

610.50.01
710.50.01



SAT

610.50.02
710.50.02



BS

610.50.002
710.50.002



CS

610.50.06



N

610.50.07



manillón Alya
pág. 56

SERIE
ALYA

Manivela con roseta
Door handle on rose

AL Aluminio Z Zamak
Aluminium Zamak

610.60 AL1.....20

710.60 Z1.....20

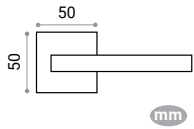

CRS 610.60.05



NS
610.60.01
710.60.01



SAT
610.60.02
710.60.02



manillón Alya
pág. 56

610.70 AL1.....20

710.70 Z1.....20

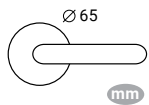

BS
610.70.002
710.70.002



NS
610.70.01
710.70.01



CS
610.70.06

Manivela con placa
Door handle on plate

SERIE
ALYA

AL Aluminio
Aluminium

610.01 AL1.....20

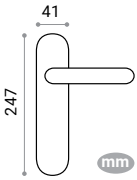

AL

HERRAJES PARA PUERTAS

NS 610.01.01

SERIE

ALYA

Manivela con placa
Door handle on plate

AL Aluminio Z Zamak
Aluminium Zamak

AL

610.21 AL1.....20

Z

710.01 Z1.....20

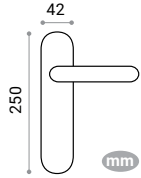

NS



610.21.01
710.01.01

SAT



610.21.02
710.01.02

BS



610.21.002
710.01.002

CRS



610.21.05

N



610.21.07

CS 610.21.06

Manivela con placa
Door handle on plate

SERIE
ALYA

AL Aluminio
Aluminium

610.31 AL  
.....1.....20

AL

HERRAJES PARA PUERTAS

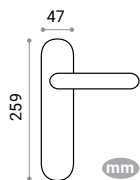

610.31.01

 610.31.02

SERIE
LYRA 



Manivela con roseta
Door handle on rose

SERIE
LYRA

AL Aluminio Z Zamak
Aluminium Zamak

611.50 AL1.....20
711.50 Z1.....20

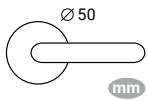

AL
Z

HERRAJES PARA PUERTAS



NS
611.50.01
711.50.01



611.50.05



611.50.02
711.50.02



611.50.002
711.50.002



611.50.06



711.50.08

SERIE

LYRA

Manivela con roseta
Door handle on rose

AL Aluminio Z Zamak
Aluminium Zamak

AL **611.70** AL  
.....1.....20

Z **711.70** Z1.....20

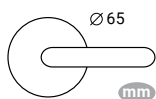

CS 611.70.06



NS
611.70.01
711.70.01



BS
611.70.002
711.70.002

SERIE

LYRA

Manivela con placa
Door handle on plate

AL Aluminio
Aluminium

611.01 AL  
.....1.....20

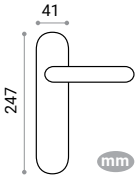

AL

HERRAJES PARA PUERTAS

NS 611.01.01

SERIE

LYRA

Manivela con placa
Door handle on plate

AL Aluminio Z Zamak
Aluminium Zamak

AL

Z

611.21 AL1.....20

711.01 Z1.....20

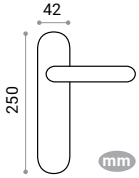

SAT



611.21.02
711.01.02

BS



611.21.002
711.01.002

CS



611.21.06

NS



611.21.01
711.01.01

PVD



711.01.08

CRS 611.21.05

Manivela con placa
Door handle on plate

SERIE
LYRA

AL Aluminio
Aluminium

611.31 AL  
.....1.....20

AL

HERRAJES PARA PUERTAS

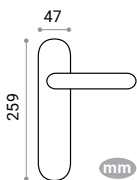

NS 611.31.01



SAT 611.31.02

SERIE

MEISSA

Manivela con roseta
Door handle on rose

AL Aluminio Z Zamak
Aluminium Zamak

AL **612.50** AL1.....20

Z **712.50** Z1.....20

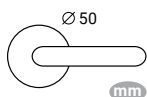

NS 612.50.01
712.50.01

AL **612.60** AL1.....20

Z **712.60** Z1.....20

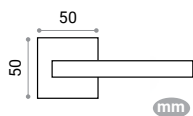

NS 612.60.01
712.60.01

SERIE
MEISSA

Manivela con placa
Door handle on plate

AL Aluminio Z Zamak
Aluminium Zamak

AL
Z

612.21 AL1.....20
712.01 Z1.....20

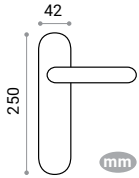

612.11 AL1.....20



NS 612.11.01

NS 612.21.01
712.01.01

SERIE
VEGA 



Manivela con roseta
Door handle on rose

SERIE
VEGA

AL Aluminio
Aluminium

613.50 AL  
.....1.....20

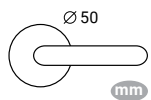

AL



N 613.50.07



NS
613.50.01



BS
613.50.002



BM
613.50.23



manillón Vega
pág. 57

SERIE
VEGA

Manivela con roseta
Door handle on rose

AL Aluminio
Aluminium

613.60 AL1.....20

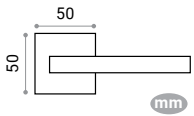

NS 613.60.01

613.70 AL1.....20

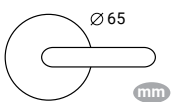

BS 613.70.002



613.60.002



613.60.07



613.60.23

*Roseta canto biselado



613.70.01



613.70.07



613.70.23

Manivela con placa
Door handle on plate

SERIE
VEGA

AL Aluminio
Aluminium

613.01 AL1.....20

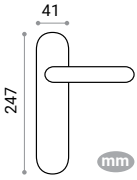

AL

HERRAJES PARA PUERTAS

NS 613.01.01

SERIE

VEGA

Manivela con placa
Door handle on plate

AL Aluminio
Aluminium

AL

613.11 AL  
.....1.....20

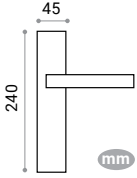

NS



613.11.01

N



613.11.07

BM



613.11.23

 613.11.002

Manivela con placa
Door handle on plate

SERIE
VEGA

AL Aluminio
Aluminium

613.21 AL  
.....1.....20

AL

HERRAJES PARA PUERTAS

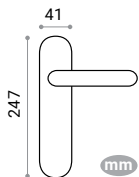

NS



613.21.01

BS



613.21.002

BM



613.21.23

 613.21.07

SERIE
GAMMA

Manivela con roseta
Door handle on rose

AL Aluminio
Aluminium

AL **614.50** AL1.....20

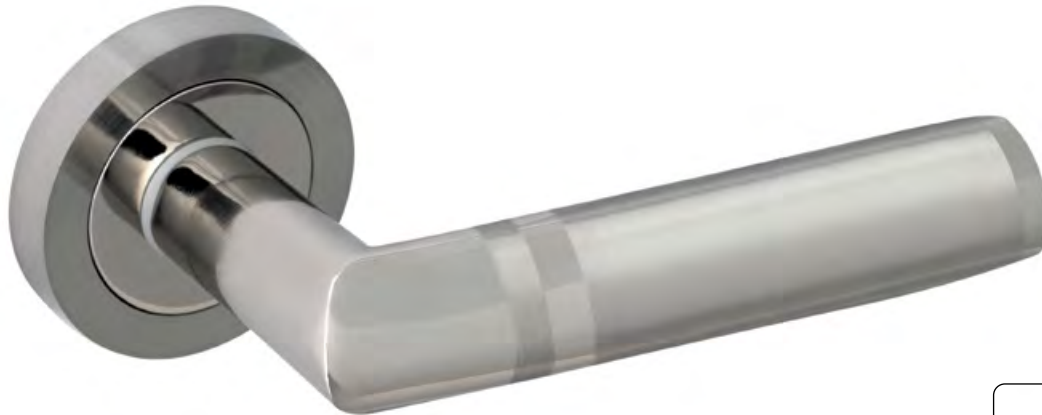
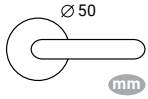

NNS 614.50.11



manillón Gamma
pág. 59

614.60 AL1.....20

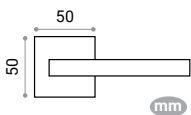

NNS 614.60.11



manillón Gamma
pág. 59

SERIE

GAMMA

Manivela con placa
Door handle on plate

AL Aluminio
Aluminium

AL

HERRAJES PARA PUERTAS

614.21 AL  
.....1.....20

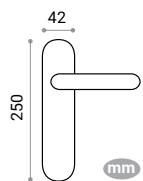

614.11 AL  
.....1.....20

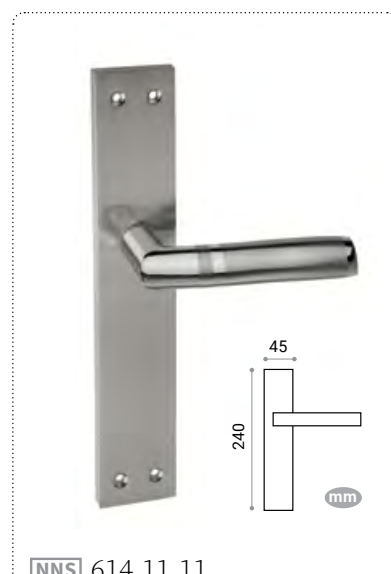

NNS 614.11.11

NNS 614.21.11

SERIE

ORION

Manivela con roseta
Door handle on rose

AL Aluminio
Aluminium

AL

615.50 AL1.....20

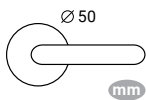

NNS 615.50.11



manillón Gamma
pág. 59

615.60 AL1.....20

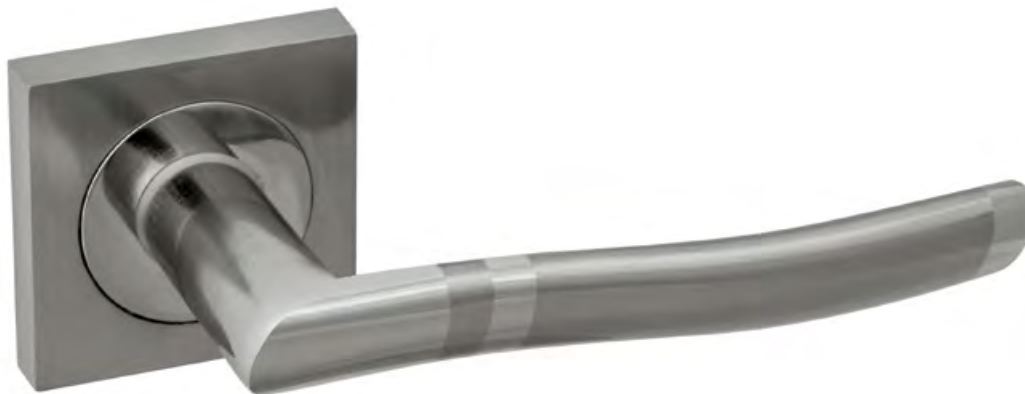
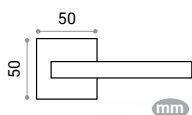

NNS 615.60.11



manillón Gamma
pág. 59

SERIE

ORION

Manivela con placa
Door handle on plate

AL Aluminio
Aluminium

615.21 AL  
.....1.....20

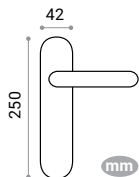

AL

HERRAJES PARA PUERTAS

NNS 615.21.11

SERIE
GAIA 



Manivela con roseta
Door handle on rose

SERIE
GAIA

AL Aluminio Z Zamak
Aluminium Zamak

616.60 AL1.....20

716.60 Z1.....20

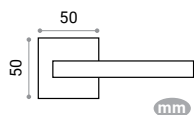

CNS
616.60.14
716.60.14



manillón Gaia 616
pág. 61



manillón Gaia 716
pág. 62

AL
Z

HERRAJES PARA PUERTAS

SERIE

GAIA

Manivela con roseta
Door handle on rose

AL Aluminio Z Zamak
Aluminium Zamak

AL **616.50**1.....20
Z **716.50**1.....20

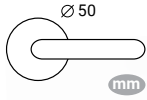

CNS

616.50.14
716.50.14



manillón Gaia 616
pág. 60



manillón Gaia 716
pág. 62

AL **616.70**1.....20
Z **716.70**1.....20

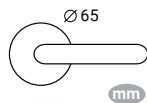

CNS

616.70.14
716.70.14

SERIE
GAIA

Manivela con placa
Door handle on plate

AL Aluminio Z Zamak
Aluminium Zamak

AL
Z

HERRAJES PARA PUERTAS

616.21 AL1.....20
716.01 Z1.....20

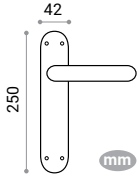

616.11 AL1.....20
716.11 Z1.....20



CNS 616.11.14
716.11.14

CNS 616.21.14
716.01.14

SERIE
SYNA

Manivela con roseta
Door handle on rose

AL Aluminio
Aluminium

AL **620.60** AL1.....20

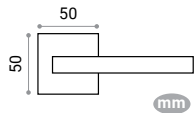

NS 620.60.01



manillón Syna
pág. 63

Manivela con placa
Door handle on plate

SERIE
SYNA

AL Aluminio
Aluminium

620.11 AL  
.....1.....20

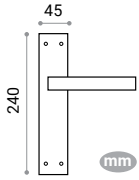

AL

HERRAJES PARA PUERTAS

NS 620.11.01

SERIE

ELECTRA

Manivela con roseta
Door handle on rose

AL Aluminio
Aluminium

AL

621.60 AL1.....20

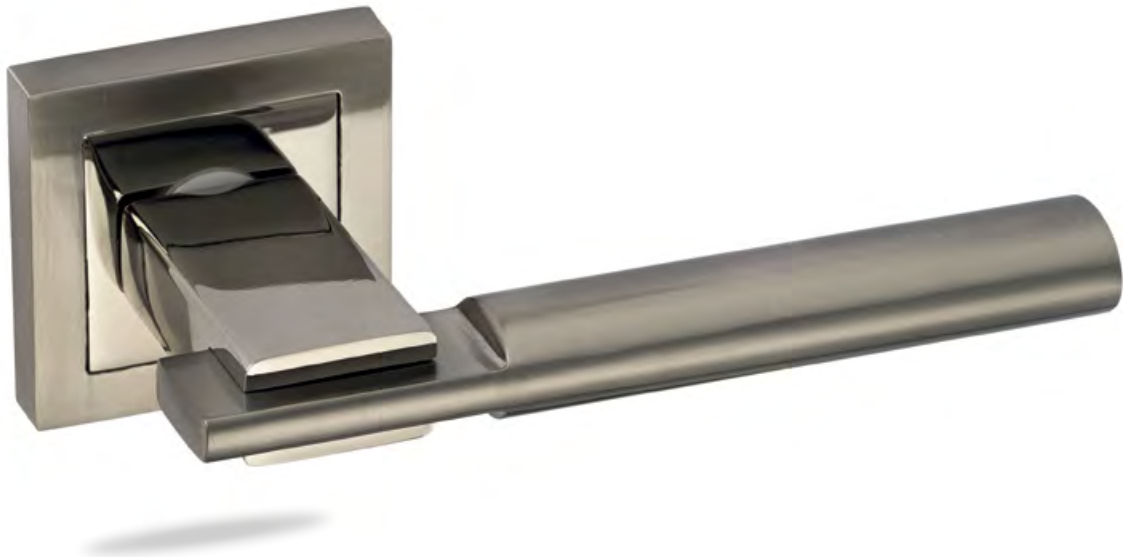
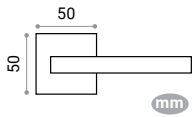

NNS 621.60.11



manillón Electra
pág. 64

SERIE
ELECTRA

Manivela con placa
Door handle on plate

AL Aluminio
Aluminium

621.11 AL  
.....1.....20

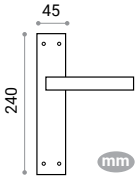

ángulo inverso
reverse angle

AL

HERRAJES PARA PUERTAS

NNS 621.11.11

SERIE

ALENA

Manivela con roseta
Door handle on rose

AL Aluminio
Aluminium

AL

623.60 AL1.....20

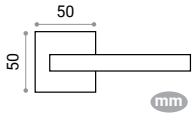

mm



CNS 623.60.14



manillón Alena
pág. 64

Manivela con placa
Door handle on plate

SERIE
ALENA

AL Aluminio
Aluminium

623.11 AL  
.....1.....20

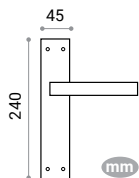

CNS 623.11.14

AL

HERRAJES PARA PUERTAS

SERIE

CORA

Manivela con roseta
Door handle on rose

AL Aluminio
Aluminium

AL

624.50 AL1.....20

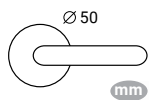

NS 624.50.01

624.60 AL1.....20

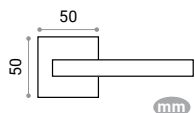

NS 624.60.01

Manivela con placa
Door handle on plate

SERIE
CORA

AL Aluminio
Aluminium

HERRAJES PARA PUERTAS

AL

624.11 AL  1.....20

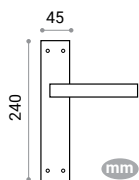

NSI 624.11.01

SERIE

SUNNA

Manivela con roseta
Door handle on rose

AL Aluminio
Aluminium

AL

625.60 AL1.....20

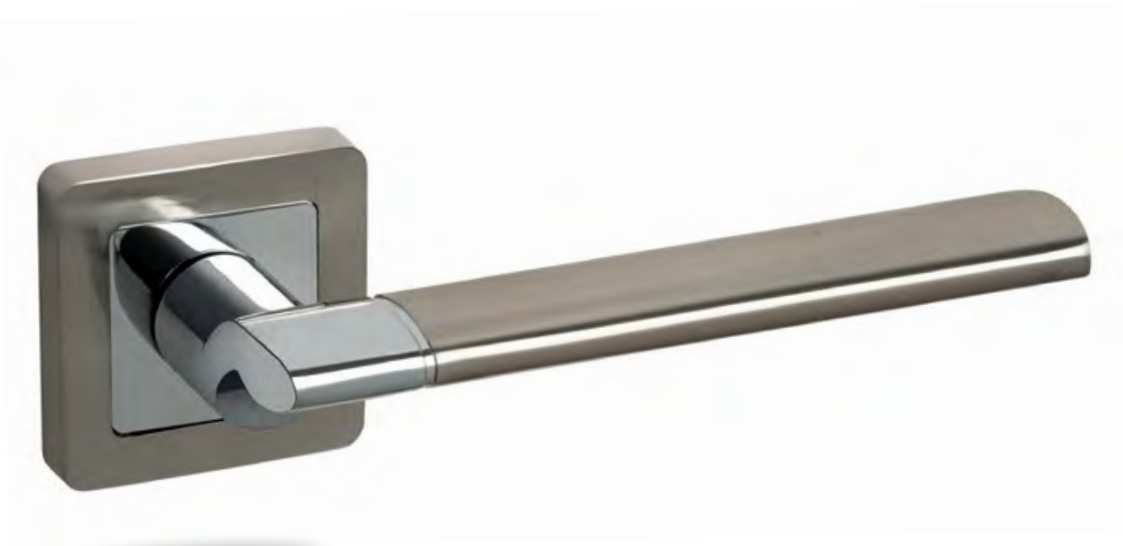
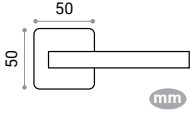

CNS 625.60.14

SERIE

SUNNA

Manivela con placa
Door handle on plate

AL Aluminio
Aluminium

625.11 AL  1.....20

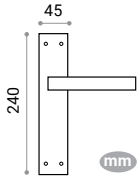

CNS 625.11.14

AL

HERRAJES PARA PUERTAS

SERIE

FREYA

Manivela con roseta
Door handle on rose

AL Aluminio
Aluminium

AL

626.60 AL1.....20

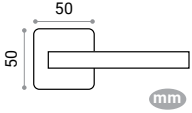

CNS 626.60.14

Manivela con placa
Door handle on plate

SERIE
FREYA

AL Aluminio
Aluminium

AL

HERRAJES PARA PUERTAS

626.11 AL  1.....20

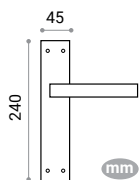

CNS 626.11.14

SERIE
DARIA 



Manivela con roseta
Door handle on rose

SERIE
DARIA

AL Aluminio
Aluminium

661.60 AL1.....20

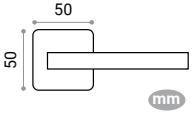

AL

HERRAJES PARA PUERTAS



N 661.60.07

NS



661.60.01

BM



661.60.23

T



661.60.15T

SERIE
DARIA

Manivela con roseta
Door handle on rose

AL Aluminio
Aluminium

AL **661.50** AL1.....20

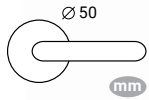

BM 661.50.23



661.50.01



661.50.07

Manivela con placa
Door handle on plate

AL Aluminio
Aluminium

AL **661.21** AL1.....20

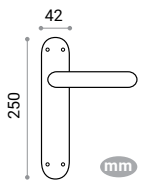

661.21.01



661.21.07



661.21.23

Manivela con placa
Door handle on plate

SERIE
DARIA

AL Aluminio
Aluminium

661.11 AL1.....20

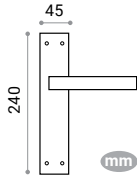

AL

HERRAJES PARA PUERTAS



T 661.11.15T

NS



661.11.01

N



661.11.07

BM



661.11.23

SERIE

EOS

Manivela con roseta
Door handle on rose

Z Zamak
Zamak

Z

717.60 Z1.....20

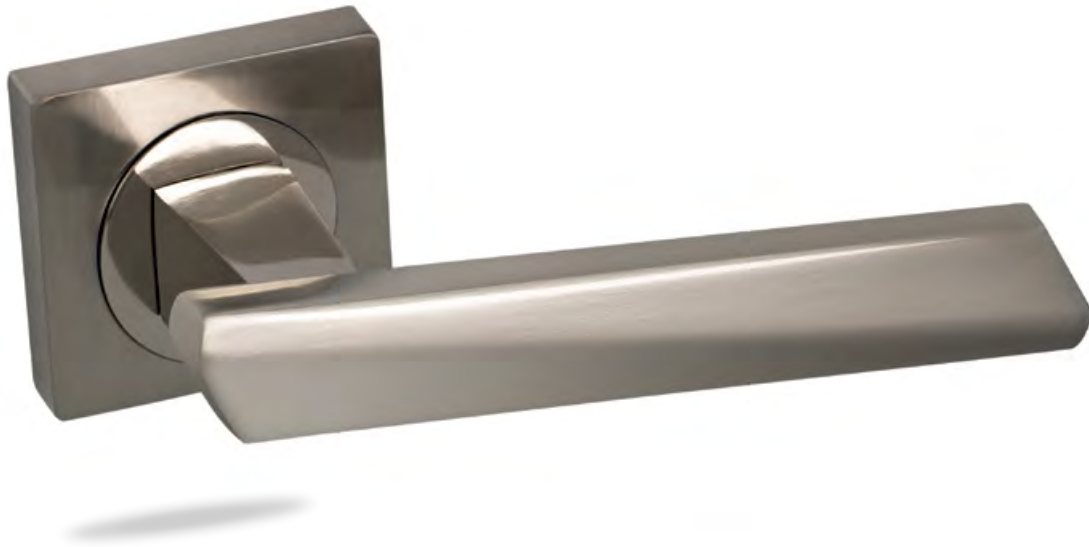
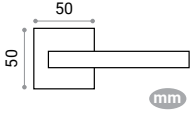

NNS 717.60.11

Manivela con placa
Door handle on plate

SERIE
EOS

Z Zamak
Zamak

Z

717.11 Z  
.....1.....20

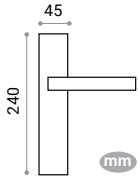

ángulo inverso
reverse angle

NNS 717.11.11

SERIE

ARES

Manivela con roseta
Door handle on rose

Z Zamak
Zamak

Z

718.50 Z  
.....1.....20

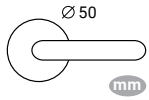

CRS 718.50.05



NS 718.50.01

718.60 Z  
.....1.....20

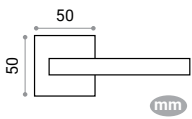

NS 718.60.01



CRS 718.60.05

Manivela con placa
Door handle on plate

SERIE
ARES

Z Zamak
Zamak

718.11 Z  
1.....20

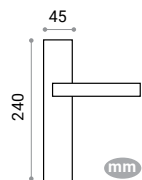

718.01 Z  
1.....20

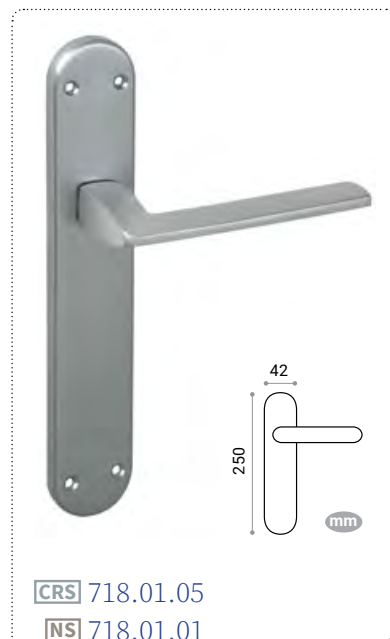

NS 718.11.01

CRS 718.11.05

Z

HERRAJES PARA PUERTAS

SERIE

IONA

Manivela con roseta
Door handle on rose

Z Zamak
Zamak

Z

719.60 Z  
.....1.....20

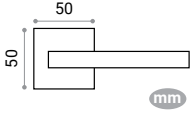

NNS 719.60.11

Manivela con placa
Door handle on plate

SERIE
IONA

Z Zamak
Zamak

719.11 Z  
.....1.....20

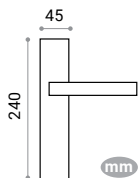

ángulo inverso
reverse angle

NNS 719.11.11

Z

HERRAJES PARA PUERTAS

SERIE

ALYA

Manillón
Pull handle on roses

AL Aluminio Z Zamak
Aluminium Zamak

AL

Z

610.55 AL1.....20

710.55 Z1.....20

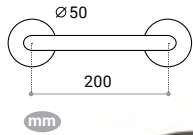

CS 610.55.06



610.55.01
710.55.01



610.55.002



610.55.07

610.65 AL1.....20

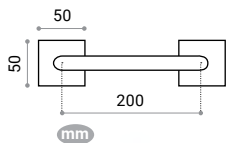

NS 610.65.01

SERIE
VEGA

Manillón
Pull handle on roses

AL Aluminio Z Zamak
Aluminium Zamak

613.55 AL1.....20
713.55 Z1.....20

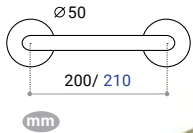

BS 613.55.002



613.55.01
713.55.01



613.55.07



613.55.23

613.66 AL1.....20

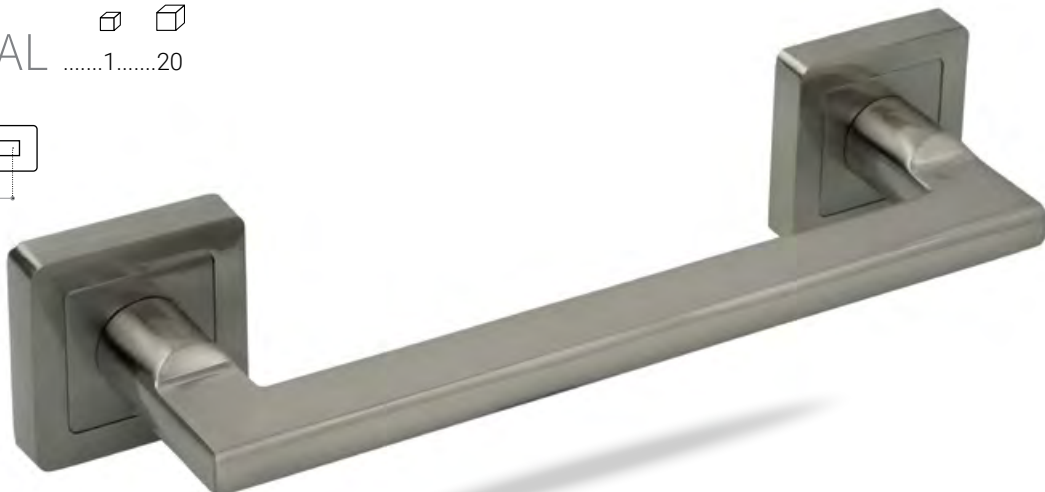
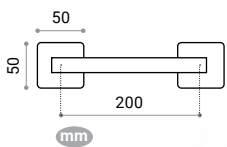

NS 613.66.01



613.66.07



613.66.15T



613.66.23

AL

Z

HERRAJES PARA PUERTAS

SERIE

VEGA

Manillón
Pull handle on roses

AL Aluminio Z Zamak
Aluminium Zamak

AL1.....20
Z1.....20

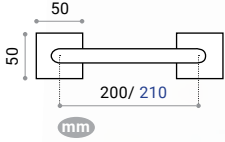

N 613.65.07

NS



613.65.01
713.65.01

BS



613.65.002



NNS 713.65.11

SERIE
GAMMA

Manillón
Pull handle on roses

Z Zamak
Zamak

Z

HERRAJES PARA PUERTAS

714.55 Z1.....20

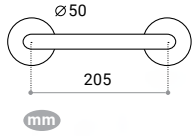

NNS 714.55.11

714.65 Z1.....20

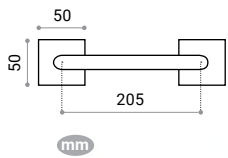

NNS 714.65.11

SERIE
GAIA

Manillón
Pull handle on roses

AL Aluminio
Aluminium

AL **616.55** AL1.....20

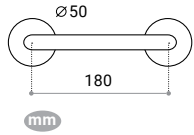

CNS 616.55.14

NS



616.55.01

BS



616.55.02

CR



616.55.04

CRS



616.55.05

CS



616.55.06

NNS



616.55.11

Manillón
Pull handle on roses

SERIE
GAIA

AL Aluminio
Aluminium

616.65 AL1.....20

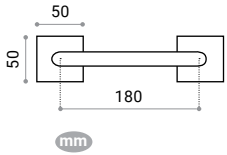

NS 616.65.01



616.65.14



616.65.11

AL

HERRAJES PARA PUERTAS

SERIE

GAIA

Manillón
Pull handle on roses

Z Zamak
Zamak

716.55 Z1.....20

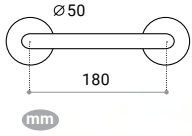

PVD 716.55.08

NS



716.55.01

CNS



716.55.14

716.65 Z1.....20

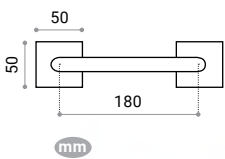

CNS 716.65.14

NS



716.65.01

Manillón
Pull handle on roses

SERIE
SYNA

AL Aluminio
Aluminium

620.55 AL1.....20

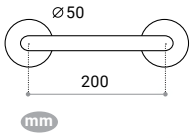

NS 620.55.01

620.65 AL1.....20

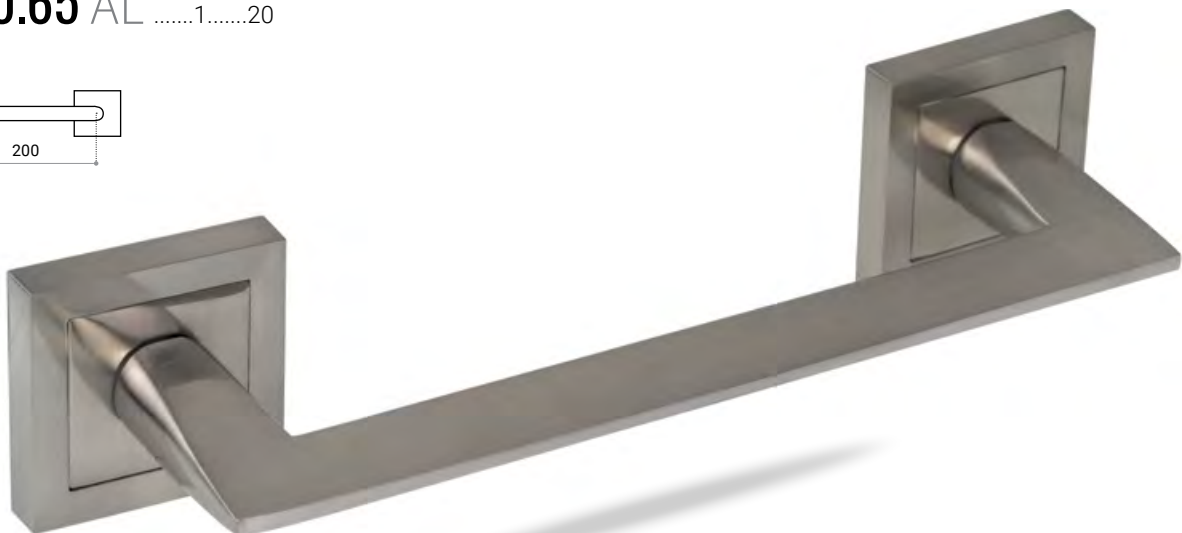
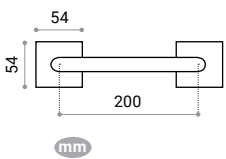

NS 620.65.01

AL

HERRAJES PARA PUERTAS

SERIE
ELECTRA

Manillón
Pull handle on roses

AL Aluminio
Aluminium

621.65 AL1.....25

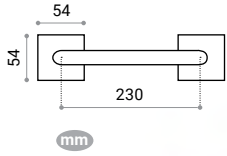

NNS 621.65.11

SERIE
ALENA

Manillón
Pull handle on roses

Z Zamak
Zamak

723.65 Z1.....25

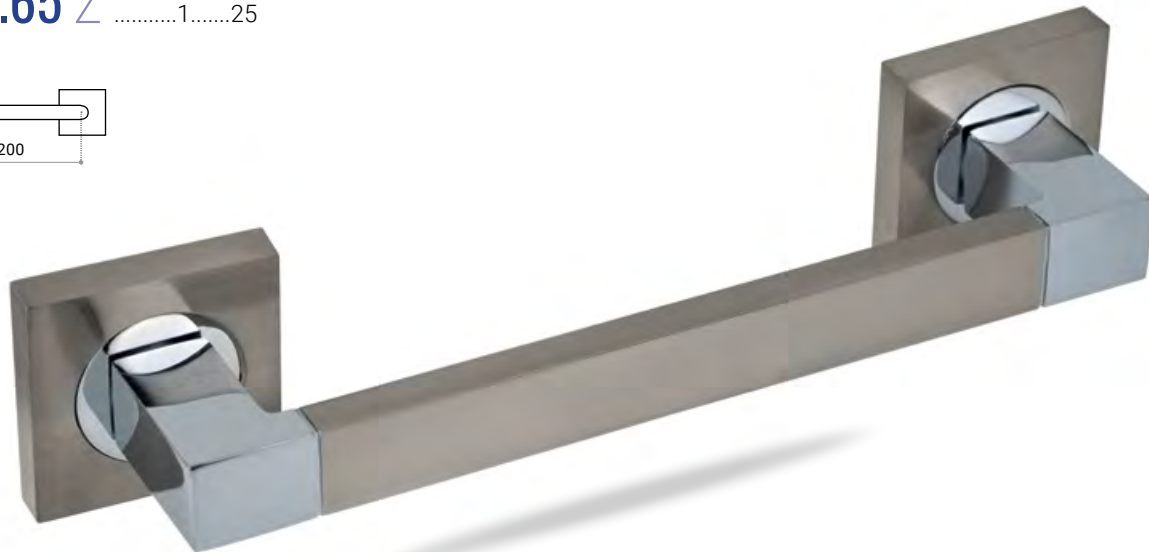
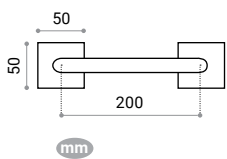

CNS 723.65.14



NNS 723.65.11

SERIE

MINERVA

HERRAJES PARA PUERTAS



SERIE

MINERVA

Manillón
Pull handle on roses

Z Zamak
Zamak

Z

761.55 Z2.....20

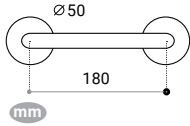

CR 761.55.04

NS



761.55.01

SAT



761.55.02

NNS



761.55.11

CNS



761.55.14

SERIE

MINERVA

Manillón

Pull handle on roses

Z Zamak

Zamak

761.65 Z  
.....2.....20

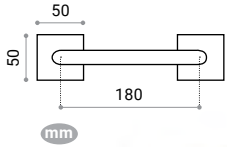

CNS 761.65.14

NS



761.65.01

SAT



761.65.02

CR



761.65.04

NNS



761.65.11

761.66 Z  
.....2.....20

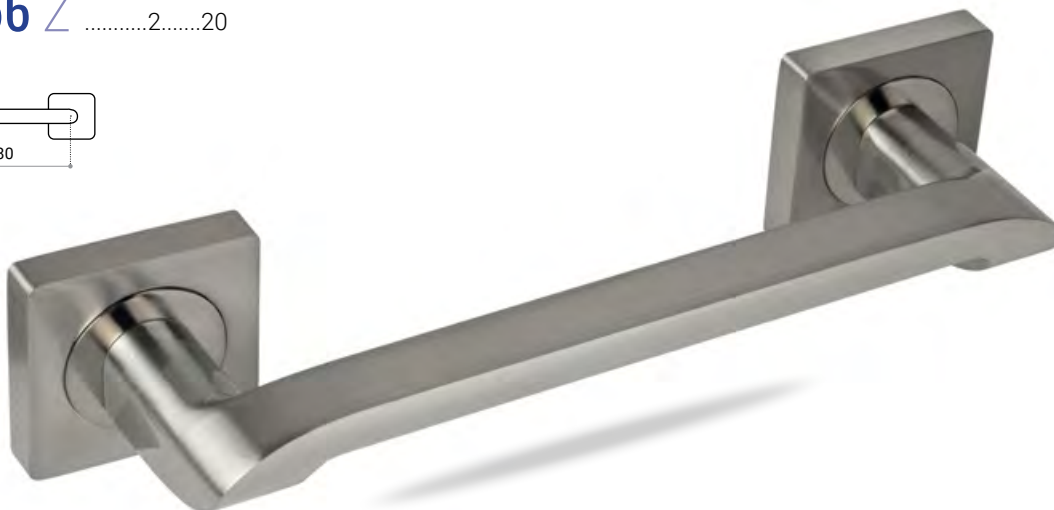
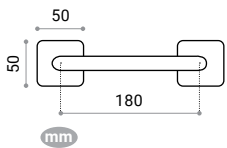

NS 761.66.01

CR



761.66.04

NNS



761.66.11

Z

HERRAJES PARA PUERTAS

Manillón con placa
Pull handle on plate

AL Aluminio Z Zamak
Aluminium Zamak

616.05 AL2.....40

710.15 Z2.....40

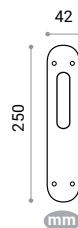
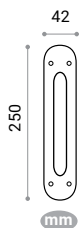

CNS 616.05.14

SAT 710.15.02

NS

BS

CR

CRS

CS

NS



616.05.01

616.05.002

616.05.04

616.05.05

616.05.06

710.15.01

Pomo fijo o móvil con placa
Knob on plate

Z Zamak
Zamak

710.14 Z  
.....2.....40

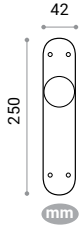

BM 710.14.23

N



710.14.07

NS



710.14.01

BS



710.14.002



Z



Pomo fijo o móvil con placa
Knob on plate

Z Zamak
Zamak

Z 620.14 Z

 
.....2.....40

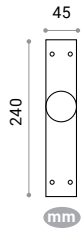

T 620.14.15T

N



620.14.07

NS



620.14.01

BM



620.14.23



Manillón con placa

Pull handle on plate

Z Zamak
Zamak

760.05 Z  
.....2.....40

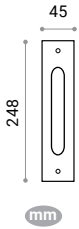

NNS 760.05.11

761.20 Z  
.....2.....40

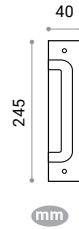

NNS 761.20.11

NS



761.20.01

Z



Tirador de armario/ Tirador de maletero
Cupboard pull/ Cabinet pull

Z Zamak
Zamak

Z

710.06 Z  
.....10.....200

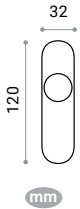

N 710.06.07

710.08 Z  
.....20.....400



BM 710.08.23

NS



710.06.01

BS



710.06.002

PB



710.06.003

NS



710.08.01

BS



710.08.002

PB



710.08.003

CRS



710.06.005

CS



710.06.006

BM



710.06.023

CRS



710.08.005

CS



710.08.006

N



710.08.007



Tirador de armario/ Tirador de maletero
 Cupboard pull/ Cabinet pull

AL Aluminio
 Aluminium

AL

620.06 AL.....5.....100



CR 620.06.04

620.08 AL.....10.....200

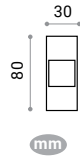

NS 620.08.01

NS



620.06.01

N



620.06.07

BM



620.06.23

CR



620.08.04

N



620.08.07

BM



620.08.23



- ① Roseta con bocallave tipo "A"/ Escutcheon with keyhole "A"
- ② Roseta con bocallave tipo "B"/ Escutcheon with keyhole "B"

Z

① 710.51 Z20.....400



NS 710.51.01

- SAT 710.51.02
- BS 710.51.002
- CR 710.51.04
- CRS 710.51.05
- CS 710.51.06
- N 710.51.07
- PVD 710.51.08
- NNS 710.51.11
- CNS 710.51.14
- BM 710.51.23

② 710.52 Z20.....400



NS 710.52.01

- SAT 710.52.02
- BS 710.52.002
- CR 710.52.04
- CRS 710.52.05
- CS 710.52.06
- N 710.52.07
- PVD 710.52.08
- NNS 710.52.11
- CNS 710.52.14

Juego condena y emergencia con roseta

Turn and release knob on roses

710.53.01 Z4.....80



NS 710.53.01

710.53 Z4.....80



N 710.53.07

- SAT 710.53.02
- BS 710.53.002
- CR 710.53.04
- CRS 710.53.05
- CS 710.53.06
- PVD 710.53.08
- NNS 710.53.11
- CNS 710.53.14
- BM 710.53.23

- ① Roseta cuadrada con bocallave tipo "A"/ Square escutcheon with keyhole "A"
- ② Roseta cuadrada con bocallave tipo "B"/ Square escutcheon with keyhole "B"

① **710.61** Z  20.....400

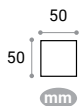

NS 710.61.01

SAT 710.61.02
CR 710.61.04
CRS 710.61.05
N 710.61.07
NNS 710.61.11
CNS 710.61.14

② **710.62** Z  20.....400

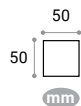

NS 710.62.01

SAT 710.62.02
CR 710.62.04
CRS 710.62.05
N 710.62.07
NNS 710.62.11
CNS 710.62.14

Z

Juego condena y emergencia con roseta cuadrada

Turn and release knob on square roses

710.63 Z  4.....80

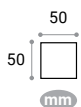

NS 710.63.01

SAT 710.63.02
CR 710.63.04
CRS 710.63.05
N 710.63.07
NNS 710.63.11
CNS 710.63.14



- ① Roseta cuadrada con bocallave tipo "A"/ Square escutcheon with keyhole "A"
- ② Roseta cuadrada con bocallave tipo "B"/ Square escutcheon with keyhole "B"

AL Aluminio
Aluminium

AL

① **620.61** AL10.....200

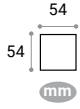

NS 620.61.01
CR 620.61.04

② **620.62** AL10.....200

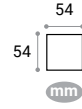

NS 620.62.01
CR 620.62.04

Juego condena y emergencia con roseta cuadrada
Turn and release knob on square roses

620.63 AL5.....100

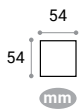

NS 620.63.01
CR 620.63.04

- ① Roseta cuadrada con bocallave tipo "A"/ Square escutcheon with keyhole "A"
- ② Juego condena y emergencia con roseta cuadrada/ Turn and release knob on square roses

① **625.61** AL20.....400

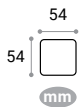

N 625.61.07
NS 625.61.01
T 625.61.15T
BM 625.61.23

② **625.63** AL4.....80



N 625.63.07
NS 625.63.01
T 625.63.15T
BM 625.63.23

Juego condena y emergencia con roseta
Turn and release knob on roses

Z Zamak
Zamak

700.35 Z10.....100



NS 700.35.01

- BS** 700.35.002
- PB** 700.35.03
- CR** 700.35.04
- CRS** 700.35.05
- CS** 700.35.06
- N** 700.35.07
- NNS** 700.35.11
- CNS** 700.35.14
- B** 700.35.13
- BM** 700.35.23

Juego condena y emergencia con roseta para puerta de 40mm
Turn and release knob on roses (40 mm thickness door)

700.40 Z10.....100



NS 700.40.01

- BS** 700.40.002
- PB** 700.40.03
- N** 700.40.07



Juego condena y emergencia con roseta cuadrada

Turn and release knob on square roses

Z Zamak
Zamak

Z

701.35 Z  
.....10.....100

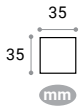

- NS** 701.35.01
- SAT** 701.35.02
- CR** 701.35.04
- CRS** 701.35.05
- N** 701.35.07
- NNS** 701.35.11
- B** 701.35.13
- CNS** 701.35.14
- T** 701.35.15T
- BM** 701.35.23

Juego condena y emergencia con roseta cuadrada para puerta de 40mm

Turn and release knob on square roses (40 mm thickness door)

701.40 Z  
.....10.....100

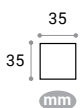

- NS** 701.40.01
- CRS** 701.40.05

Condena con desbloqueo
Turn and release knob

Z Zamak
Zamak

702.00 Z  
.....20.....200



- NS** 702.00.01
- BS** 702.00.002
- PB** 702.00.03
- CR** 702.00.04
- CRS** 702.00.05
- CS** 702.00.06
- N** 702.00.07
- B** 702.00.13
- BM** 702.00.23

Condena con desbloqueo para puerta de 40mm
Turn and release knob (40 mm thickness door)

702.40 Z  
.....20.....200



- NS** 702.40.01
- BS** 702.40.002
- PB** 702.40.03

Condena
Turn knob

704.00 Z  
.....20.....200



- NS** 704.00.01
- BS** 704.00.002
- PB** 704.00.03

Z

SERIE
CLÁSICA : : :



- ① Manivela con placa
Door handle on plate
- ② Manillón con placa
Pull handle on plate

SERIE
CLÁSICA

Z Zamak
Zamak

① **910.01** Z2.....20

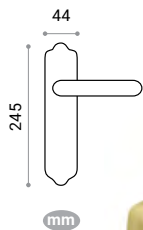

BS 910.01.002

② **910.05** Z4.....40



BS 910.05.002

Z

HERRAJES PARA PUERTAS

- ① Manivela con placa
Door handle on plate
- ② Manillón con placa
Pull handle on plate

SERIE
CLÁSICA

AL Aluminio
Aluminium

AL

① **911.01** AL2.....20

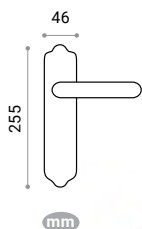

BS 911.01.002

② **911.05** AL4.....40

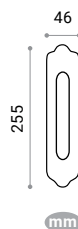

CS 911.05.06

NS

BS



911.05.01 911.05.002

Manivela con placa
Door handle on plate

SERIE
CLÁSICA

AL Aluminio
Aluminium

913.01 AL  
.....2.....20

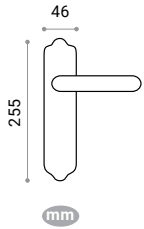

NS 913.01.01



913.01.002

913.01.06

AL

HERRAJES PARA PUERTAS

- ① Tirador de armario
Cupboard pull
- ② Tirador de maletero
Cabinet pull

SERIE
CLÁSICA

Z Zamak
Zamak

Z

① **910.06** Z25.....250

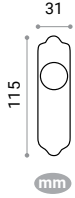

NS 910.06.01

② **910.08** Z25.....250

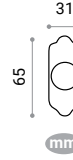

CS 910.08.06

BS



910.06.002

CS



910.06.06

NS



910.08.01

BS



910.08.002

SERIE
CLÁSICA

Manivela con placa
 Door handle on plate

Z Zamak
 Zamak

960.01 Z  
 1.....20

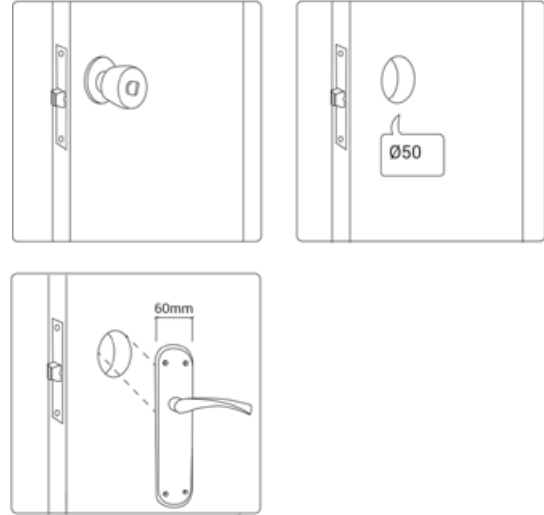
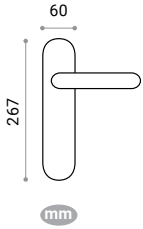

Z

HERRAJES PARA PUERTAS



BS



960.01.002

N



960.01.07

NS 960.01.01

Manillón con placa
Pull handle on plate

SERIE
CLÁSICA

Z Zamak
Zamak

Z

960.05 Z  
.....2.....40



NS 960.05.01



BS 960.05.002

Manivela con placa
Door handle on plate

SERIE
CLÁSICA

Z Zamak
Zamak

HERRAJES PARA PUERTAS

Z

963.01 Z  
.....1.....20

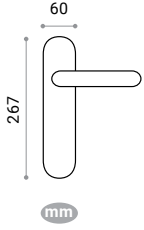

NS 963.01.01



963.01.002



963.01.07

SERIE
LATÓN :: ::



- ① Manivela con placa
Door handle on plate
- ② Manillón con placa
Pull handle on plate

SERIE
LATÓN

L Latón
Brass

① **950.01** L1.....20

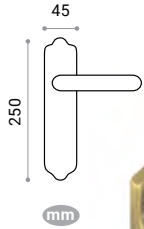

CS 950.01.06

② **950.05** L2.....40



CS 950.05.06



950.01.002



950.05.002

L

HERRAJES PARA PUERTAS

- ① Tirador de armario
Cupboard pull
- ② Tirador de maletero
Cabinet pull

SERIE
LATÓN

L Latón
Brass

L

① **950.06** L10.....100

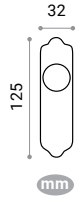

② **950.08** L10.....100

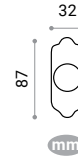

CS 950.06.06



CS 950.08.06

SERIE
LATÓN

Manivela con placa
Door handle on plate

L Latón
Brass

953.01 L1.....20

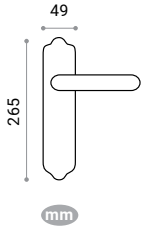

CS 953.01.06



BS 953.01.002

L

HERRAJES PARA PUERTAS

SERIE
PORCELANA



SERIE PORCELANA

BLANCA

Manivela con placa
Door handle on plate

L Latón
Brass

HERRAJES PARA PUERTAS

L

951.01 L1.....20

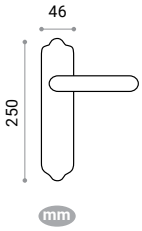

CS 951.01.06

NS

PB

ANTIC



951.01.01

951.01.03

951.01.09

SERIE PORCELANA

BLANCA

Manivela con roseta
Door handle on rose

L Latón
Brass

L **951.50** L1.....20

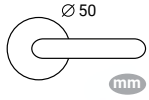

ANTIC 951.50.09



NS 951.50.01

PB



951.50.03

CS



951.50.06

SERIE PORCELANA

BLANCA

Manillón

Pull handle on roses

L Latón
Brass

951.55 L2.....40

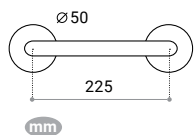

ANTIC 951.55.09



NS 951.55.01



951.55.03



951.55.06

L

HERRAJES PARA PUERTAS

SERIE PORCELANA
CRACKELE

Manivela con roseta
Door handle on rose

L Latón
Brass

L

952.50 L1.....20

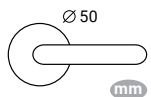

ANTIC 952.50.09

CS



952.50.06

Manillón
Pull handle on roses

952.55 L2.....40

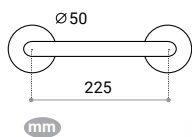

CS 952.55.06

ANTIC



952.55.09

SERIE PORCELANA

CRACKELE

Manivela con placa
Door handle on plate

L Latón
Brass

952.01 L

.....1.....20

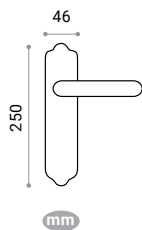

ANTIC 952.01.09



CS 952.01.06

L

HERRAJES PARA PUERTAS



① Tirador de armario/ Cupboard pull

② Tirador de maletero/ Cabinet pull

L Latón

Brass

L

① 952.06 L10.....100

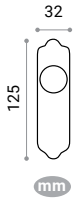

ANTIC 952.06.09



CS 952.06.06

② 952.08 L10.....100

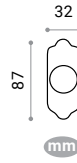

CS 952.08.06



ANTIC 952.08.09

① Pomito porcelana crackelé/ Porcelain Knob

② Pomito porcelana blanco/ Porcelain Knob

① 952.28 L10.....100



952.28.00

② 951.28 L10.....100



951.28.00

- ① Roseta con bocallave tipo "A"/ Escutcheon with keyhole "A"
- ② Roseta con bocallave tipo "B"/ Escutcheon with keyhole "B"

L Latón
Brass

① 950.51 L20.....400



ANTIC 950.51.09

NS 950.51.01
PB 950.51.03
CS 950.51.06

② 950.52 L20.....400



ANTIC 950.52.09

NS 950.52.01
PB 950.52.03
CS 950.52.06

Juego condena y emergencia con roseta

Turn and release knob on roses

950.53 L4.....100



ANTIC 950.53.09

NS 950.53.01
PB 950.53.03
CS 950.53.06

Juego condena y emergencia con roseta

Turn and release knob on roses

950.35 L10.....100



ANTIC 950.35.09

NS 950.35.01
PB 950.35.03
CS 950.35.06

SERIE PORCELANA
NEGRA

Manivela con roseta y Manillón
Door and pull handle on roses

Z Zamak
Zamak

Z **740.50** Z1.....20

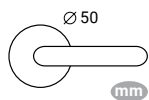

N 740.50.07

Z **740.55** Z2.....40

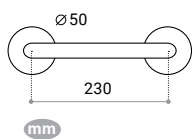

N 740.55.07

SERIE PORCELANA

NEGRA

Manivela con placa
Door handle on plate

Z Zamak
Zamak

HERRAJES PARA PUERTAS

Z

740.01 Z1.....20

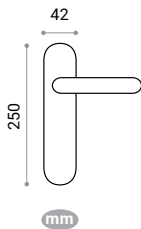

 740.01.07

SERIE
ACERO 



SERIE INOXIDABLE

ACERO

Manivela "U" con roseta
"U" Door handle on rose

IN Acero inoxidable
Stainless Steel

810.50 IN1.....20



IN

HERRAJES PARA PUERTAS

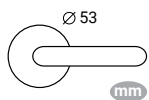

IN 810.50.01



810.50.07



manillón
pág. 120

SERIE INOXIDABLE

ACERO

Manivela "U"
oscilobatiente (8 posiciones)
"U" Window handle (8 positions)

IN Acero inoxidable
Stainless Steel

IN

810.17 IN

.....1.....20

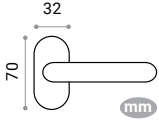

IN 810.17.01

Manivela "U" con roseta oval
"U" Door handle on oval rose

810.18 IN

.....1.....20

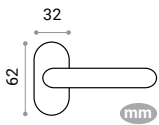

IN 810.18.01

SERIE INOXIDABLE

ACERO

Manivela "U" con placa
"U" Door handle on plate

IN Acero inoxidable
Stainless Steel

810.01 IN1.....20



IN

HERRAJES PARA PUERTAS

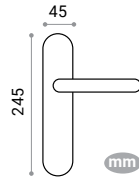

IN 810.01.07



manillón
pág. 122



IN 810.01.01

810.10 IN1.....20

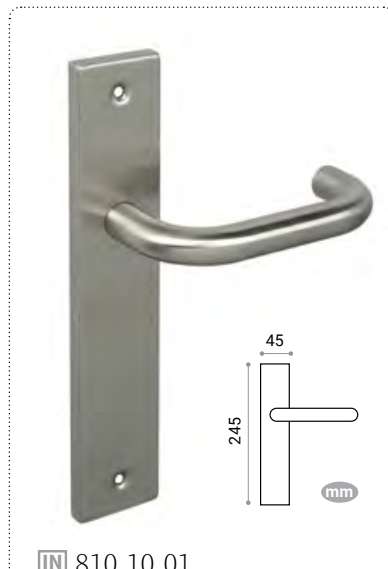

IN 810.10.01

820.01 IN1.....20

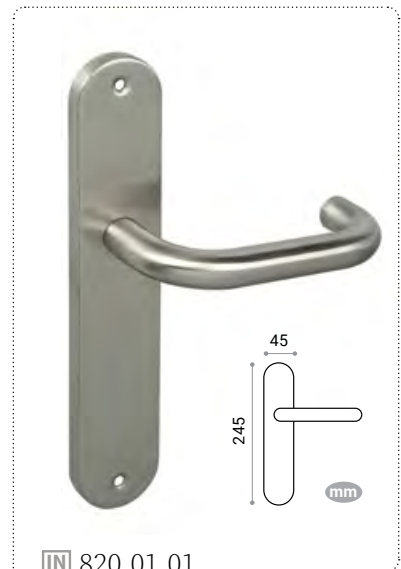

IN 820.01.01

SERIE INOXIDABLE

ACERO

Manivela "L" con roseta
"L" Door handle on rose

IN Acero inoxidable
Stainless Steel

IN

811.50 IN1.....20

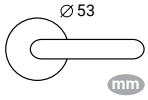

IN 811.50.07



IN 811.50.01
811.50.01SS316



manillón
pág. 120

Manivela "L"
oscilobatiente (8 posiciones)
"L" Window handle (8 positions)

811.17 IN1.....20

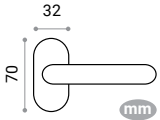

IN 811.17.01



Manivela "L" con roseta oval
"L" Door handle on oval rose

811.18 IN1.....20

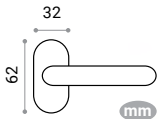

IN 811.18.01



Manivela "L" con placa
"L" Door handle on plate

SERIE INOXIDABLE
ACERO

IN Acero inoxidable
Stainless Steel

811.01 IN1.....20



IN

HERRAJES PARA PUERTAS

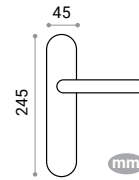

IN 811.01.01



manillón
pág. 122

821.01S IN

821.01 IN

821.10 IN

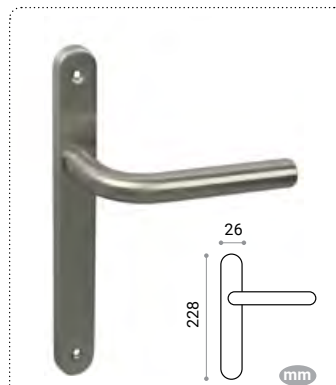

821.01S.01
821.02S.70 C/B"A" 70mm
821.02S.85 C/B"A" 85mm
821.02S.92 C/B"A" 92mm

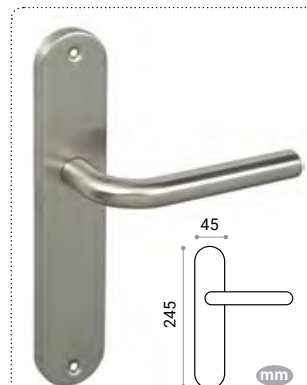

IN 821.01.01

821.01.01SS316

IN 821.01.07

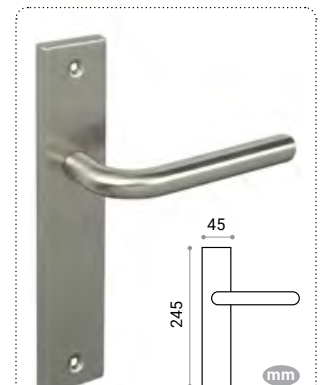

IN 821.10.01

IN 811.01.07

SERIE INOXIDABLE

ACERO

Manivela "L" recta
Straight "L" Door handle on rose

IN Acero inoxidable
Stainless Steel

812.50 IN1.....20

812.60 IN1.....20

AISI 304
18/8

IN

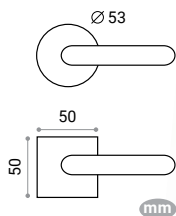

IN 812.60.01



812.50.01



812.50.07



manillón
pág. 120

Manivela "L" recta oscilobatiente (8 posiciones)
Straight "L" Window handle (8 positions)

812.17 IN1.....20

AISI 304
18/8

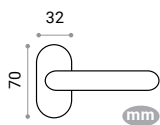

IN 812.17.01

Manivela "L" recta con roseta oval
Straight "L" Door handle on oval rose

812.18 IN1.....20

AISI 304
18/8

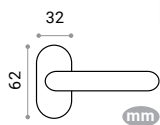

IN 812.18.01

SERIE INOXIDABLE

ACERO

Manivela "L" recta con placa
Straight "L" Door handle on plate

IN Acero inoxidable
Stainless Steel

812.01 IN  
.....1.....20



IN

HERRAJES PARA PUERTAS

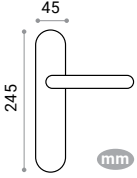

822.01 IN  
.....1.....20

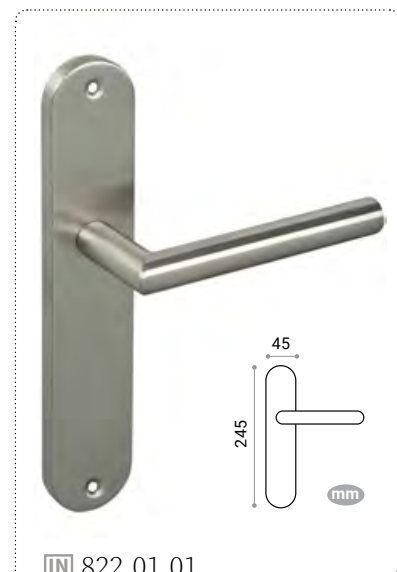

IN 822.01.01

IN 812.01.01

SERIE INOXIDABLE

ACERO

Manivela con roseta

Door handle on rose

IN Acero inoxidable

Stainless Steel



IN

813.60 IN.....1.....20

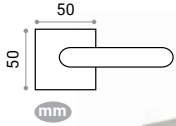

IN 813.60.01



manillón
pág. 121

Manivela con placa

Door handle on plate



823.01 IN.....1.....20

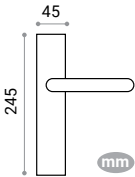

IN 823.01.01



823.01.07

SERIE INOXIDABLE

ACERO

Manivela con roseta

Door handle on rose

IN Acero inoxidable

Stainless Steel

814.60 IN1.....20

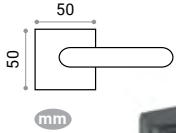

N 814.60.07



IN



814.60.01

HERRAJES PARA PUERTAS

Manivela con placa

Door handle on plate

824.01 IN1.....20

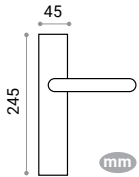

N 824.01.07



824.01.01

SERIE INOXIDABLE

ACERO

Manivela con roseta
Door handle on rose

IN Acero inoxidable
Stainless Steel



IN 815.50 IN1.....20

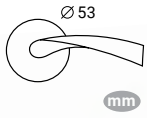

IN 815.50.01

Manivela oscilobatiente (8 posiciones)
Window handle (8 positions)



IN 815.17 IN1.....20

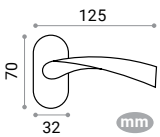

IN 815.17.01

SERIE INOXIDABLE

ACERO

Manivela con placa
Door handle on plate

IN Acero inoxidable
Stainless Steel

825.01 IN  
.....1.....20



IN

HERRAJES PARA PUERTAS

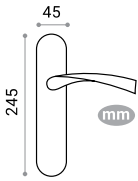

815.01 IN  
.....1.....20

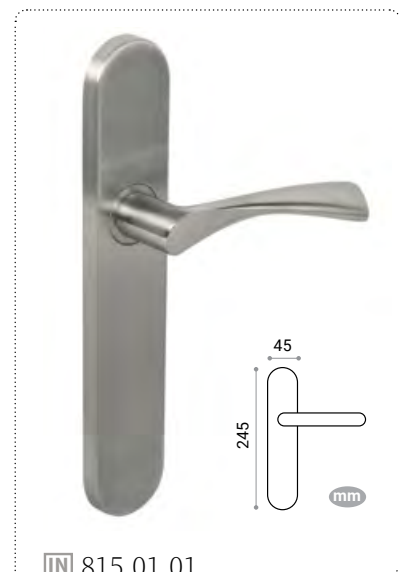

 825.01.01

 815.01.01

SERIE
ACERO 



SERIE INOXIDABLE

ACERO

Manivela con roseta

Door handle on rose

IN Acero inoxidable

Stainless Steel

816.50 IN  
.....1.....20

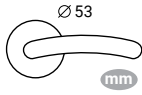

IN

HERRAJES PARA PUERTAS



 816.50.01

Manivela con placa

Door handle on plate

826.01 IN  
.....1.....20

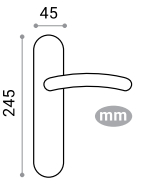

 826.01.01

SERIE INOXIDABLE

ACERO

Manivela con roseta
Door handle on rose

IN Acero inoxidable
Stainless Steel

817.50 IN  
.....1.....20

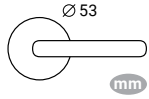

IN 817.50.01

Manivela con placa
Door handle on plate

817.01 IN  
.....1.....20

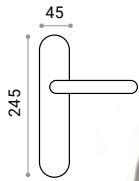

IN 817.01.01

827.01 IN  
.....1.....20

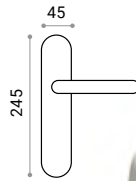

IN 827.01.01

SERIE INOXIDABLE

ACERO

Pomo con roseta
Door knob on rose

IN Acero inoxidable
Stainless Steel

1800.50 IN  3.....60



IN

HERRAJES PARA PUERTAS

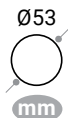

IN 1800.50.01

Pomo con roseta cuadrada
Door knob on square rose

1800.60 IN  3.....60

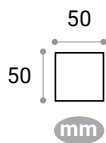

IN 1800.60.01

- ① Roseta con bocallave tipo "A"/ Escutcheon with keyhole "A"
- ② Roseta con bocallave tipo "B"/ Escutcheon with keyhole "B"

IN Acero inoxidable
Stainless Steel

① 810.51 IN  20...200



SAT 810.51.02

CS 810.51.06

N 810.51.07

PVD 810.51.08

IN 810.51.01

810.51.01SS316



IN 810.51.00

② 810.52 IN  20...200



IN 810.52.01

N 810.52.07

Juego condena y desbloqueo con roseta

Turn and release knob on roses

810.53 IN  1.....50



IN 810.53.01

810.53.01SS316

N 810.53.07



Juego condena y desbloqueo con indicador con roseta

Turn and release knob with indicator on roses

810.53 IN  1.....50



IN 810.53.10



- ① Roseta cuadrada con bocallave tipo "A"/ Square escutcheon with keyhole "A"
- ② Roseta cuadrada con bocallave tipo "B"/ Square escutcheon with keyhole "B"
- ③ Roseta Oval con bocallave tipo "A"/ Oval escutcheon with keyhole "A"

IN Acero inoxidable
Stainless Steel

① 810.61 IN20.....200

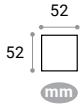

IN 810.61.01
N 810.61.07

② 810.62 IN20.....200

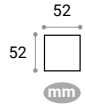

IN 810.62.01

③ 810.56 IN20.....200



IN 810.56.01
N 810.56.07



IN

HERRAJES PARA PUERTAS

- ① Juego condena y desbloqueo con roseta/ Turn and release knob on roses
- ② Condena con desbloqueo/ Turn and release knob

① 810.63 IN1.....50

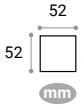

IN 810.63.01
N 810.63.07

② 810.54 IN10.....100



IN 810.54.01



Juego condena y emergencia con roseta
Turn and release knob on roses

800.35 IN1.....50



IN 800.35.01
N 800.35.07

801.35 IN1.....50

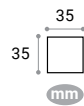

IN 801.35.01
N 801.35.07



SERIE INOXIDABLE

ACERO

Manillón

Pull handle on rose

IN Acero inoxidable
Stainless Steel



IN

810 IN10.....50

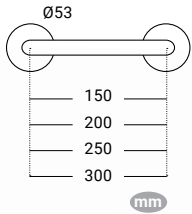

150 mm

IN 810.40.01

810.40.01SS316

N 810.40.07

200 mm



IN 810.41.01

810.41.01SS316

N 810.41.07

250 mm



IN 810.42.01

300 mm



IN 810.43.01

812 IN10.....50

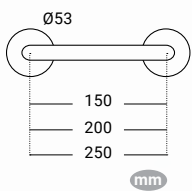

150 mm

IN 812.40.01

200 mm



IN 812.41.01

250 mm



IN 812.42.01

SERIE INOXIDABLE

ACERO

Manillón
Pull handle on rose

IN Acero inoxidable
Stainless Steel



IN

HERRAJES PARA PUERTAS

813 IN10.....50

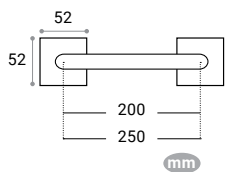

200 mm
IN 813.41.01
IN 813.41.07



IN 813.42.01

815 IN10.....50

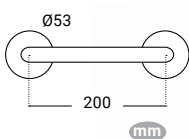

200 mm
IN 815.55.01

SERIE INOXIDABLE

ACERO

- ① Manillón/ Pull handle on plate
- ② Placa con pomo/ Knob on plate
- ③ Placa limpieza/ Finger plate

IN Acero inoxidable
Stainless Steel

① 820.05 IN1.....25



② 820.14 IN2.....20

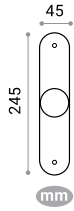

③ 820.09 IN10....50



IN 820.05.01



IN 820.14.01
820.14.01SS316
IN 820.14.07



IN 820.09.01

SERIE INOXIDABLE

ACERO

Placa con pomo
Knob on plate

IN Acero inoxidable
Stainless Steel

820.14R IN  
.....2.....40



824.14 IN  
.....2.....40

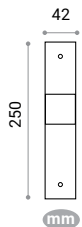

IN

HERRAJES PARA PUERTAS



 820.14R.01



 824.14.01

SERIE INOXIDABLE

ACERO

IN Acero inoxidable
Stainless Steel

Manivela "U" con placa
"U" Door handle on plate



810.11 IN1.....10

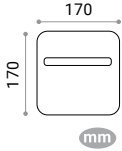

IN 810.11.01



IN 810.11.07

Manillón con placa
Pull handle on plate

810.30 IN2.....20

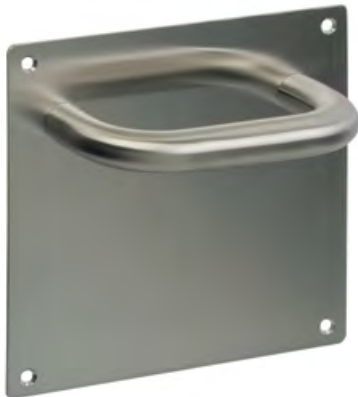
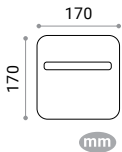

IN 810.30.01



IN 810.30.07

Placa limpiaza
Finger plate

810.20 IN10.....50

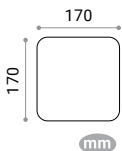

IN 810.20.01



IN 810.20.07

SERIE INOXIDABLE
ACERO

Manivela "L" con placa
"L" Door handle on plate

IN Acero inoxidable
Stainless Steel

811.11 IN1.....10



IN

HERRAJES PARA PUERTAS

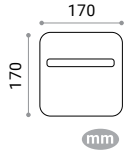

IN 811.11.01

Manivela "L" recta con placa
Straight "L" Door handle on plate

812.11 IN1.....10

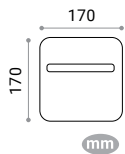

IN 812.11.01

SERIE INOXIDABLE

ACERO

Manivela "U" con placa
"U" Door handle on plate

IN Acero inoxidable
Stainless Steel

810.11 IN1.....10

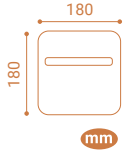

IN 810.11.01SS316

Manillón con placa/ Pull handle on plate

810.30 IN2.....20

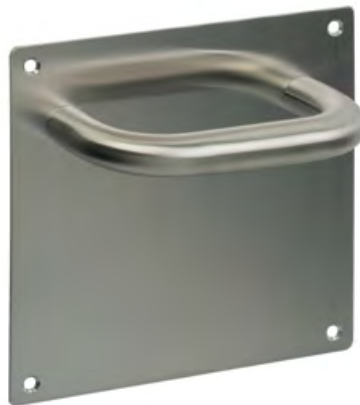
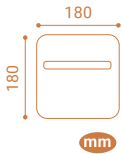

IN 810.30.01SS316

Placa limpieza/ Finger plate

810.20 IN10.....50

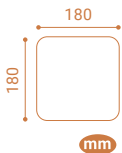

IN 810.20.01SS316

SERIE INOXIDABLE
ACERO 
PUERTAS DE CRISTAL

HERRAJES PARA PUERTAS



Manillón para puerta cristal

Glass door pull handle

* Montaje también apto para puerta de madera
* It can be also assembled in wooden doors.

IN Acero inoxidable
Stainless Steel



Manillón cuadrado

Square pull handle

440 IN1.....20



MEDIDAS (mm)	REF.	AC.	(mm)	REF.	AC.	
25	200	440.01.20	IN	200	440.25.07.20	N
25	250	440.01.25	IN	250	440.25.07.25	N
300	300	440.01.30	IN	300	440.25.07.30	N
350	350	440.01.35	IN	350	440.25.07.35	N
400	400	440.01.40	IN			
450	450	440.01.45	IN			

MEDIDAS (mm)	REF.	AC.	(mm)	REF.	AC.	
20	200	440.02.20	IN	200	440.07.20	N
20	250	440.02.25	IN	250	440.07.25	N
300	300	440.02.30	IN	300	440.07.30	N
350	350	440.02.35	IN			
400	400	440.02.40	IN			
450	450	440.02.45	IN			

Manillón tubular

Tubular pull handle

441 IN1.....20



MEDIDAS (mm)	REF.	AC.	(mm)	REF.	AC.	
Ø19	200	441.01.20	IN	200	441.04.20	CR
Ø19	250	441.01.25	IN	250	441.04.25	CR
Ø19	300	441.01.30	IN	300	441.04.30	CR
Ø19	350	441.01.35	IN	350	441.04.35	CR
Ø19	400	441.01.40	IN	400	441.04.40	CR
Ø19	450	441.01.45	IN	450	441.04.45	CR

(mm)	REF.	AC.
200	441.07.20	N
250	441.07.25	N
300	441.07.30	N
350	441.07.35	N

SERIE INOXIDABLE

ACERO

Manillón para puerta cristal

Glass door pull handle

* Montaje también apto para puerta de madera

* It can be also assembled in wooden doors.

IN Acero inoxidable
Stainless Steel



Manillón "T" cuadrado

"T" Square pull handle

442 IN1.....20



MEDIDAS **mm** REF. AC.

	C	L	REF.	AC.
	250	400	442.01.25	IN
	400	600	442.01.40	IN
	600	800	442.01.60	IN
	800	1000	442.01.80	IN
	1000	1200	442.01.100	IN

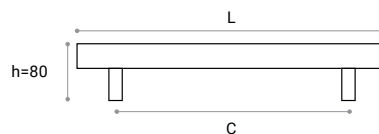

Manillón cuadrado desplazado

Offset square pull handle

443 IN1.....20



MEDIDAS **mm** REF. AC.

	C	L	REF.	AC.
	400	430	443.01.40	IN
	600	630	443.01.60	IN
	800	830	443.01.80	IN

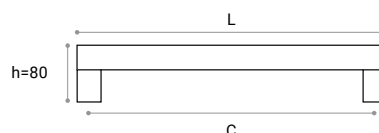

Manillón "T" tubular

"T" Tubular Pull handle

444 IN1.....20



MEDIDAS **mm** REF. AC.

	C	L	REF.	AC.
	250	400	444.01.25	IN
	400	600	444.01.40	IN
	600	800	444.01.60	IN
	800	1000	444.01.80	IN
	1000	1200	444.01.100	IN

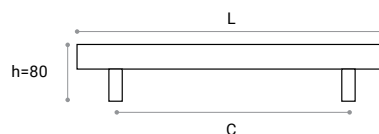

IN

HERRAJES PARA PUERTAS

KITS PUERTAS

CORREDERAS



KITS PUERTAS CORREDERAS

Z Zamak
Zamak

Kit puerta corredera

Sliding door lock with escutcheons and small pull rossette

1030.01 Z  
.....1.....10

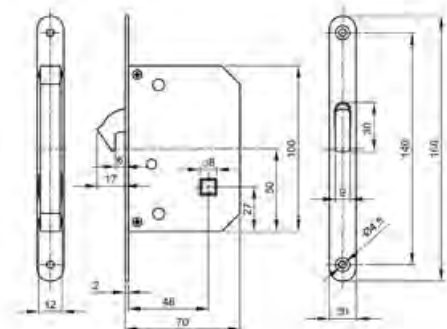

- NS** 1030.01.01
- SAT** 1030.01.02
- PB** 1030.01.03
- CR** 1030.01.04

- CRS** 1030.01.05
- CM** 1030.01.005
- CS** 1030.01.06
- N** 1030.01.07

- P** 1030.01.12
- B** 1030.01.13
- T** 1030.01.15T

Kit puerta corredera con tiradores de 60 mm

Sliding door lock with escutcheons 60 mm and small pull rossette

1030.60 Z  
.....1.....10

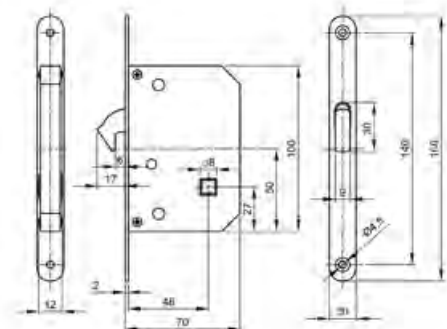

- NS** 1030.60.01

CORREDERAS

Kit cuadrado puerta corredera

Sliding door lock with square escutcheons and small square pull rossette

Z

1032.01 Z  
.....1.....10



- | | |
|------------------------|----------------------|
| NS 1032.01.01 | N 1032.01.07 |
| SAT 1032.01.02 | P 1032.01.12 |
| CR 1032.01.04 | B 1032.01.13 |
| CRS 1032.01.05 | T 1032.01.15T |
| CRM 1032.01.005 | |

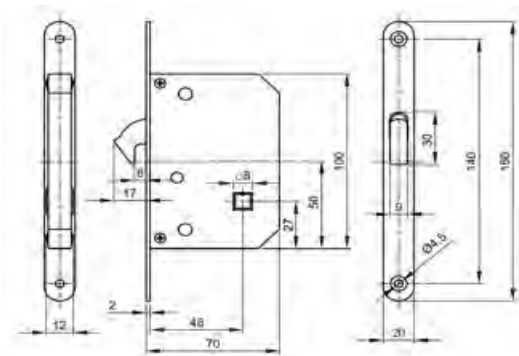

KITS PUERTAS CORREDERAS

Z Zamak
Zamak

Z

Kit puerta corredera con bocallave "A" y cilindro 40 mm con 3 llaves

Sliding door lock with keyhole "A", round escutcheons with small pull rosette and cylinder 40 mm 3 keys

1030.12 Z  
.....1.....10

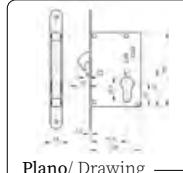

Plano/ Drawing
pág. 137



Ø55
mm

Ø30
mm

- | | |
|-----------------------|----------------------|
| NS 1030.12.01 | CS 1030.12.06 |
| SAT 1030.12.02 | N 1030.12.07 |
| PB 1030.12.03 | B 1030.12.13 |
| CRS 1030.12.05 | T 1030.12.15T |

Kit cuadrado puerta corredera con bocallave "A" y cilindro 40 mm con 3 llaves

Sliding door lock with keyhole "A", square escutcheons with small pull rosette and cylinder 40 mm 3 keys

1032.12 Z  
.....1.....10

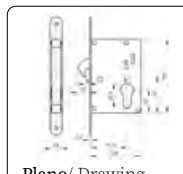

Plano/ Drawing
pág. 137

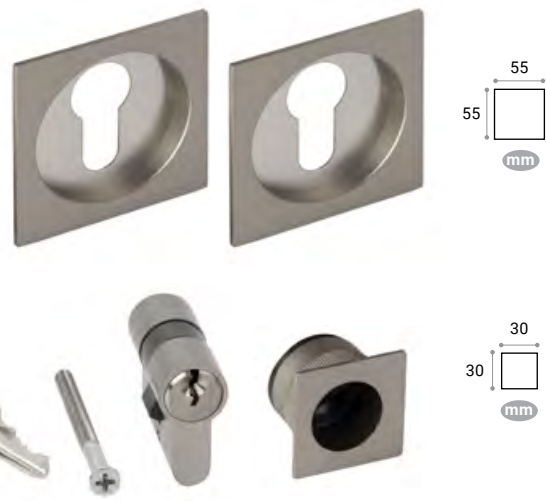

55
55
mm

30
30
mm

- | | |
|-----------------------|----------------------|
| NS 1032.12.01 | P 1032.12.12 |
| SAT 1032.12.02 | B 1032.12.13 |
| CR 1032.12.04 | T 1032.12.15T |
| N 1032.12.07 | |

CORREDERAS

Kit tiradores puerta corredera y uñero

Sliding door escutcheons and small pull rossette

1035.01 Z  
.....5.....50



NS 1035.01.01	CRS 1035.01.05	P 1035.01.12
SAT 1035.01.02	CRM 1035.01.005	B 1035.01.13
PB 1035.01.03	CS 1035.01.06	T 1035.01.15T
CR 1035.01.04	N 1035.01.07	

Kit tiradores puerta corredera 60 mm y uñero

Sliding door escutcheons 60 mm with small pull rossette

1035.60 Z  
.....3.....30



NS 1035.60.01

KITS PUERTAS CORREDERAS

Z Zamak
Zamak

Kit tiradores cuadrados puerta corredera y uñero
Square sliding door escutcheon and small square pull rossette

1036.01 Z  
.....5.....50

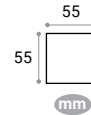
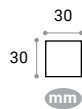

NS	1036.01.01	N	1036.01.07
SAT	1036.01.02	P	1036.01.12
CR	1036.01.04	B	1036.01.13
CRS	1036.01.05	T	1036.01.15T
CRM	1036.01.005		

Kit tiradores ovals puerta corredera y uñero
Oval sliding door escutcheons and small pull rossette

1135.01 Z  
.....5.....50

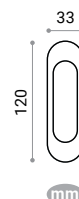

NS	1135.01.01
SAT	1135.01.02
PB	1135.01.03

Z

HERRAJES PARA PUERTAS

CORREDERAS

Uñeros

Small pull rossettes

1037.01 Z20.....200



NS 1037.01.01 **CS** 1037.01.06
SAT 1037.01.02 **N** 1037.01.07
PB 1037.01.03 **B** 1037.01.13

1037.02 Z20.....200



NS 1037.02.01

Tiradores puerta corredera

Sliding door escutcheons

1038.01 Z10.....100



NS 1038.01.01
SAT 1038.01.02
PB 1038.01.03

1038.02 Z10.....100



NS 1038.02.01

Tiradores puerta corredera con bocallave "A"

Sliding door escutcheons with keyhole "A"

1038.11 Z10.....100



NS 1038.11.01

1038.12 Z10.....100

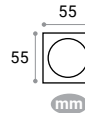

NS 1038.12.01

PUERTAS

CORREDERAS

Z Zamak
Zamak

Cerradura puerta corredera con bocallave "A"
Sliding door lock with keyhole "A"

1030.02 Z  
.....3.....30

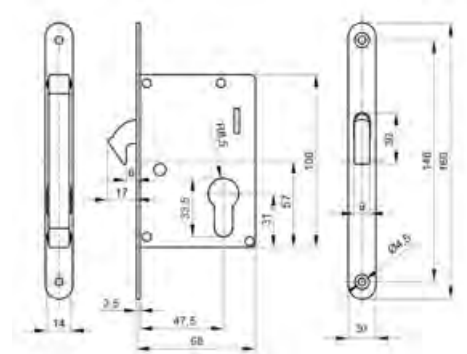

NS 1030.02.01

Cerradura puerta corredera
Sliding door lock

1030.03 Z  
.....3.....30

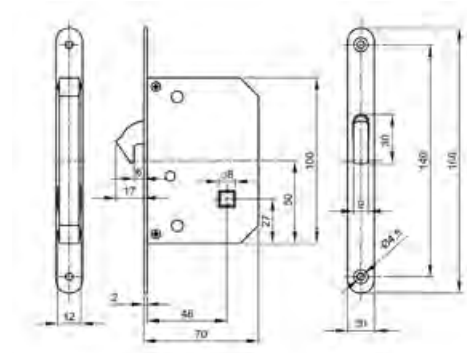

NS 1030.03.01
PB 1030.03.03

Z

HERRAJES PARA PUERTAS

KITS PUERTAS

CORREDERAS



Kit puerta corredera de cristal
Sliding glass door kit

885 AC

Espesor de la puerta de cristal: 8-12 mm
Glass door thickness: 8-12 mm

Peso máximo de la puerta: 120 kg
Max. door weight: 120 kg

Longitud de la guía: 2m - 3m
Guide length: 2m - 3m



Componentes del kit

Kit components

885

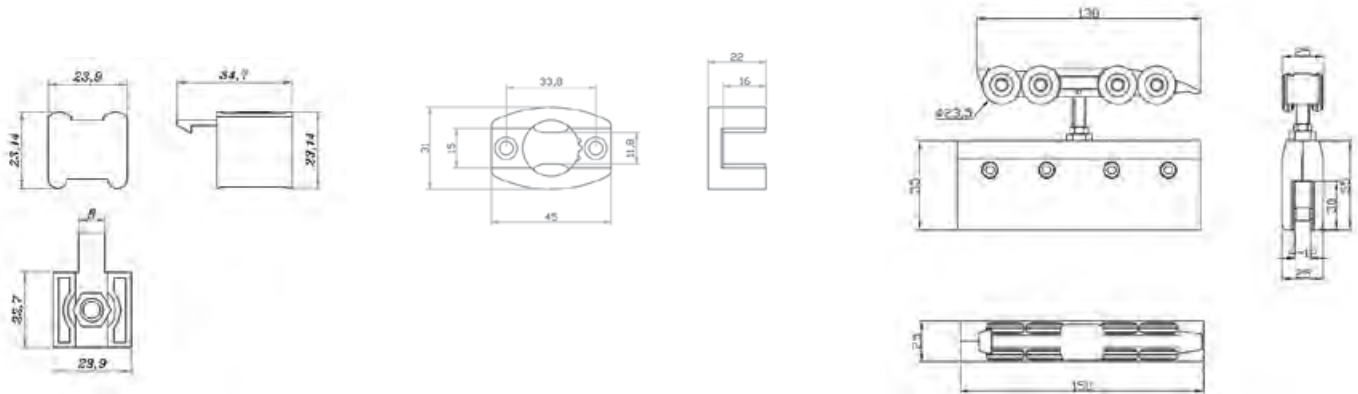
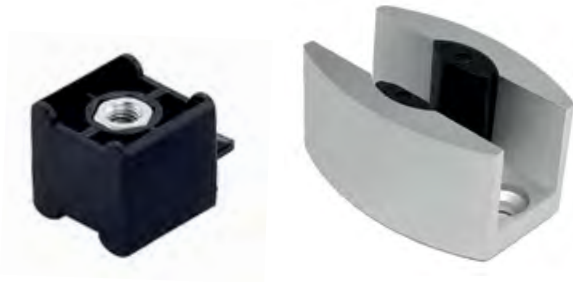

- 885.20.01 AC.....1 Kit puerta cristal con carril de 2 metros
Sliding glass door kit – 2m long
- 885.30.01 AC.....1 Kit puerta cristal con carril de 3 metros
Sliding glass door kit – 3m long
- 885.21.01 AC.....1 Kit puerta doble de cristal
Supplementary glass door kit
- 885.20.04 AL.....1 Embellecedor frontal de 2 metros
Front cover 2 meter long
- 885.30.04 AL.....1 Embellecedor frontal de 3 metros
Front cover 3 meter long
- 885.20.03 AL.....1 Embellecedor lateral
Side cover

Acero inoxidable
Stainless Steel

- 886.00.02 IN.....1 Tirador
Pull handle



KITS PUERTAS

CORREDERAS



Kit puerta corredera de cristal
Sliding glass door kit

886...0C IN

Espesor de la puerta de cristal: 8-12 mm
Glass door thickness: 8-12 mm

Peso máximo de la puerta: 120 kg
Max. door weight: 120 kg

Longitud de la guía: 2m - 2'5 m - 3m
Guide length: 2m - 2'5m - 3m

Componentes del kit

Kit components

886...0C



886.20.010C IN1 Kit puerta cristal con carril de 2 metros
 Sliding glass door kit – 2m long

886.25.010C IN1 Kit puerta cristal con carril de 2,5 metros
 Sliding glass door kit – 2,5 m long

886.30.010C IN1 Kit puerta cristal con carril de 3 metros
 Sliding glass door kit – 3m long

886.21.010C IN1 Kit puerta doble de cristal
 Supplementary glass door kit

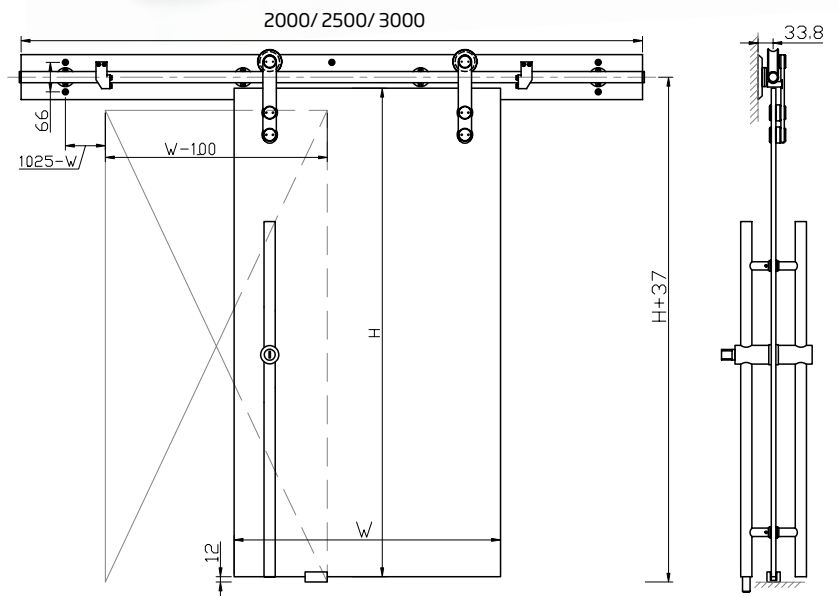

886.00.02 IN1 Tirador
 Pull handle



886.06.01 IN1 Separador 6,8 mm
 Spacer 6,8 mm



KITS PUERTAS

CORREDERAS

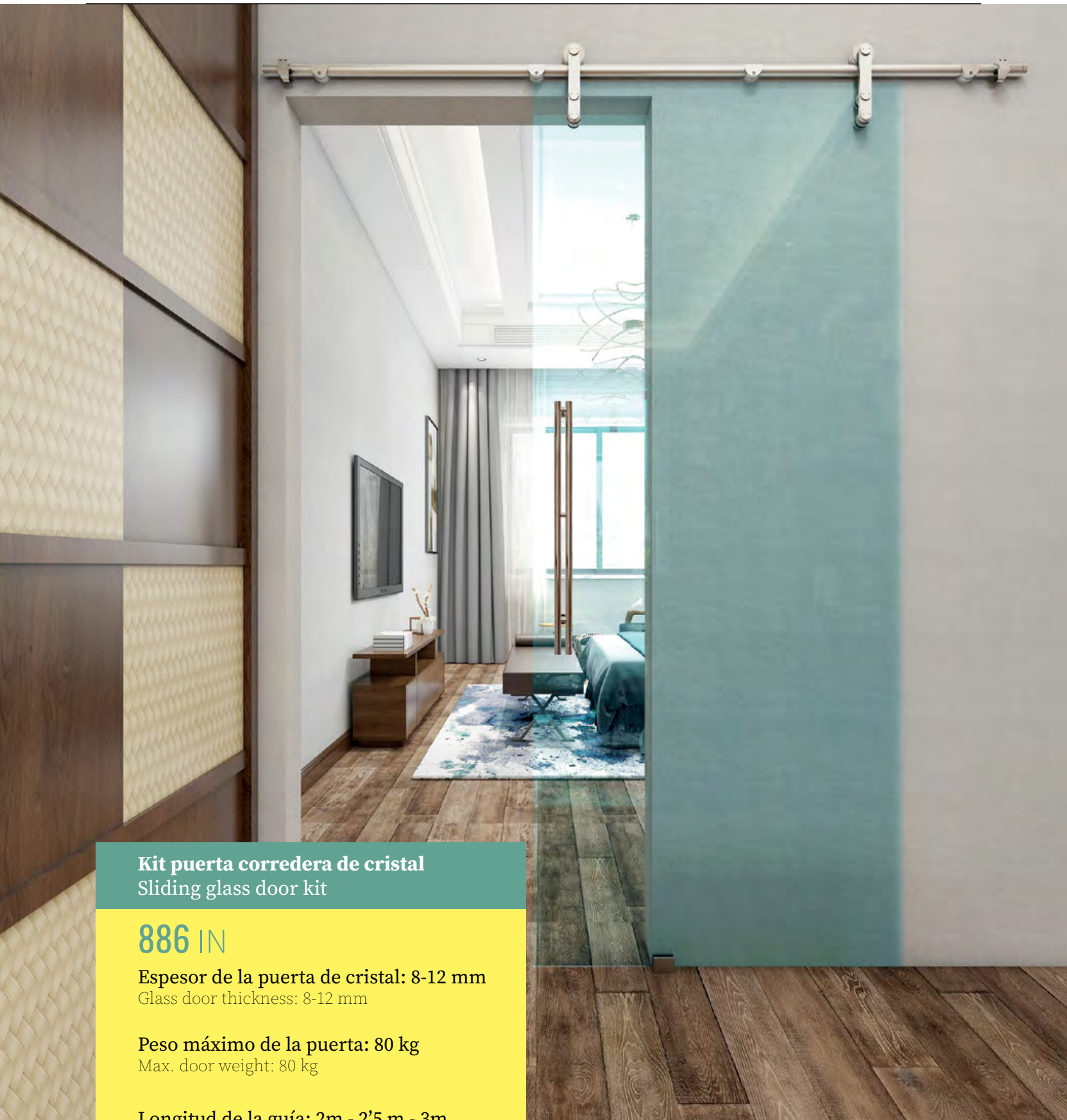

Kit puerta corredera de cristal
Sliding glass door kit

886 IN

Espesor de la puerta de cristal: 8-12 mm
Glass door thickness: 8-12 mm

Peso máximo de la puerta: 80 kg
Max. door weight: 80 kg

Longitud de la guía: 2m - 2'5 m - 3m
Guide length: 2m - 2'5m - 3m

CORREDERAS

Acero inoxidable
Stainless Steel

AISI 304
18/8

IN

HERRAJES PARA PUERTAS

Componentes del kit

Kit components

886



- 886.20.01 IN.....1 Kit puerta cristal con carril de 2 metros
Sliding glass door kit – 2m long
- 886.25.01 IN.....1 Kit puerta cristal con carril de 2.5 metros
Sliding glass door kit – 2.5m long
- 886.30.01 IN.....1 Kit puerta cristal con carril de 3 metros
Sliding glass door kit – 3m long
- 886.21.01 IN.....1 Kit puerta doble de cristal
Supplementary glass door kit

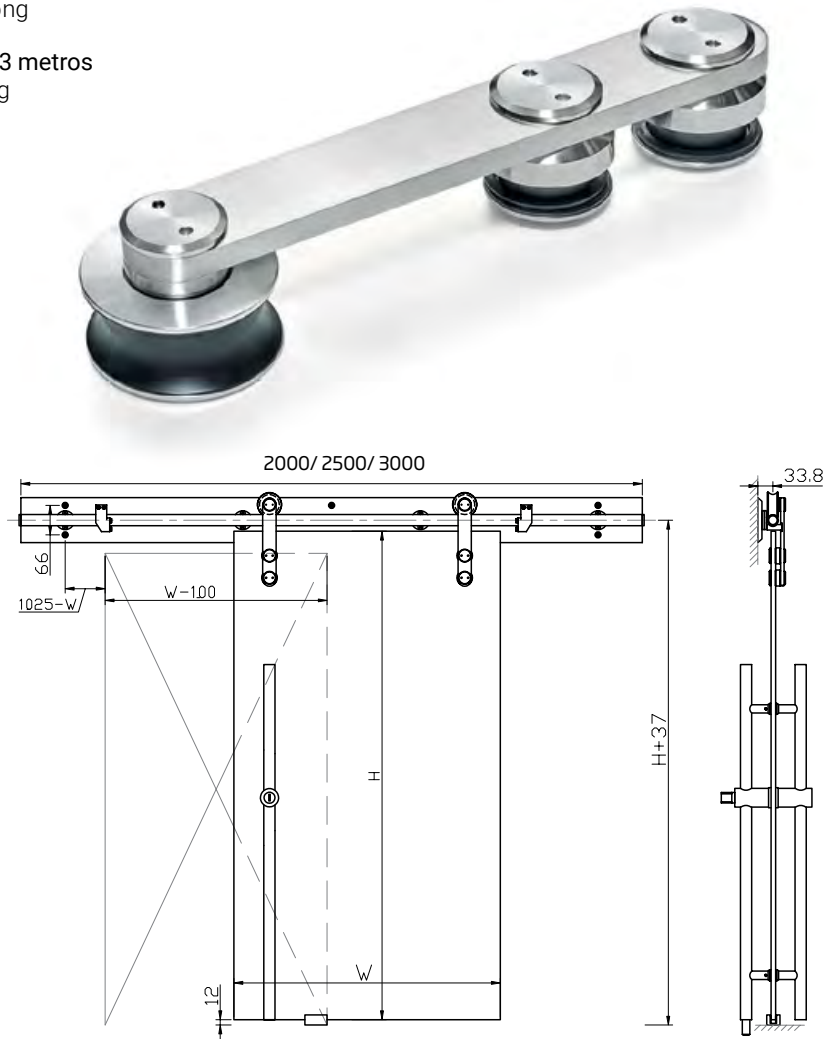

- 886.00.02 IN1  Tirador
Pull handle



- 886.06.01 IN1  Separador 6,8 mm
Spacer 6,8 mm



KITS PUERTAS

CORREDERAS



Kit puerta corredera de paso
Sliding wooden door kit

887

Espesor de la puerta: 35-45 mm
Door thickness: 35-45 mm

Peso máximo de la puerta: 80 kg
Max. door weight: 80 kg

Longitud de la guía: 2m - 2'5 m - 3m
Guide length: 2m - 2'5m - 3m

CORREDERAS

Acero inoxidable
Stainless Steel

AISI 304
18/8

Componentes del kit

Kit components

887

- 887.20.01 IN1  Kit puerta corredera 2 metros
Sliding door kit 2 meter long
- 887.25.01 IN1 Kit puerta corredera 2,5 metros
Sliding door kit 2,5 meter long
- 887.30.01 IN1 Kit puerta corredera 3 metros
Sliding door kit 3 meter long
- 887.21.01 IN1 Kit adicional puerta doble
Additional kit for double door

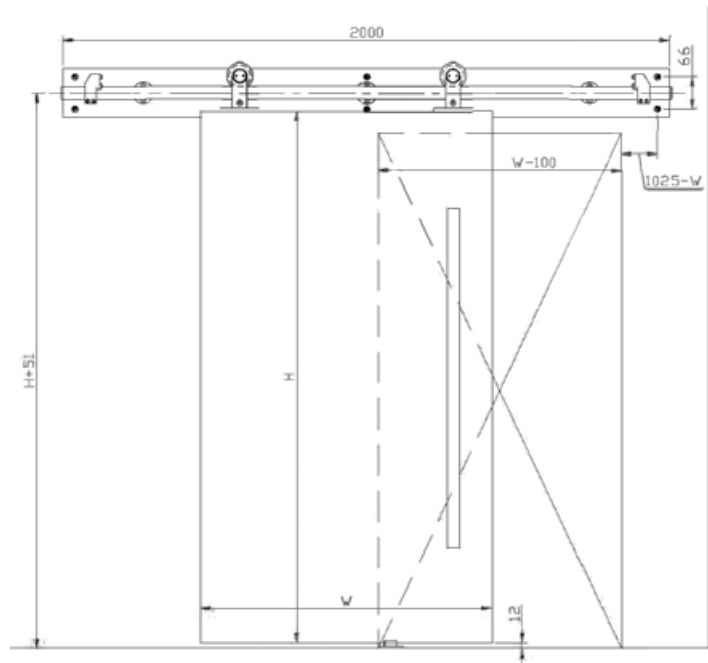

- 886.06.01 IN1  Separador 6,8 mm
Spacer 6,8 mm



IN

HERRAJES PARA PUERTAS

KITS PUERTAS

CORREDERAS

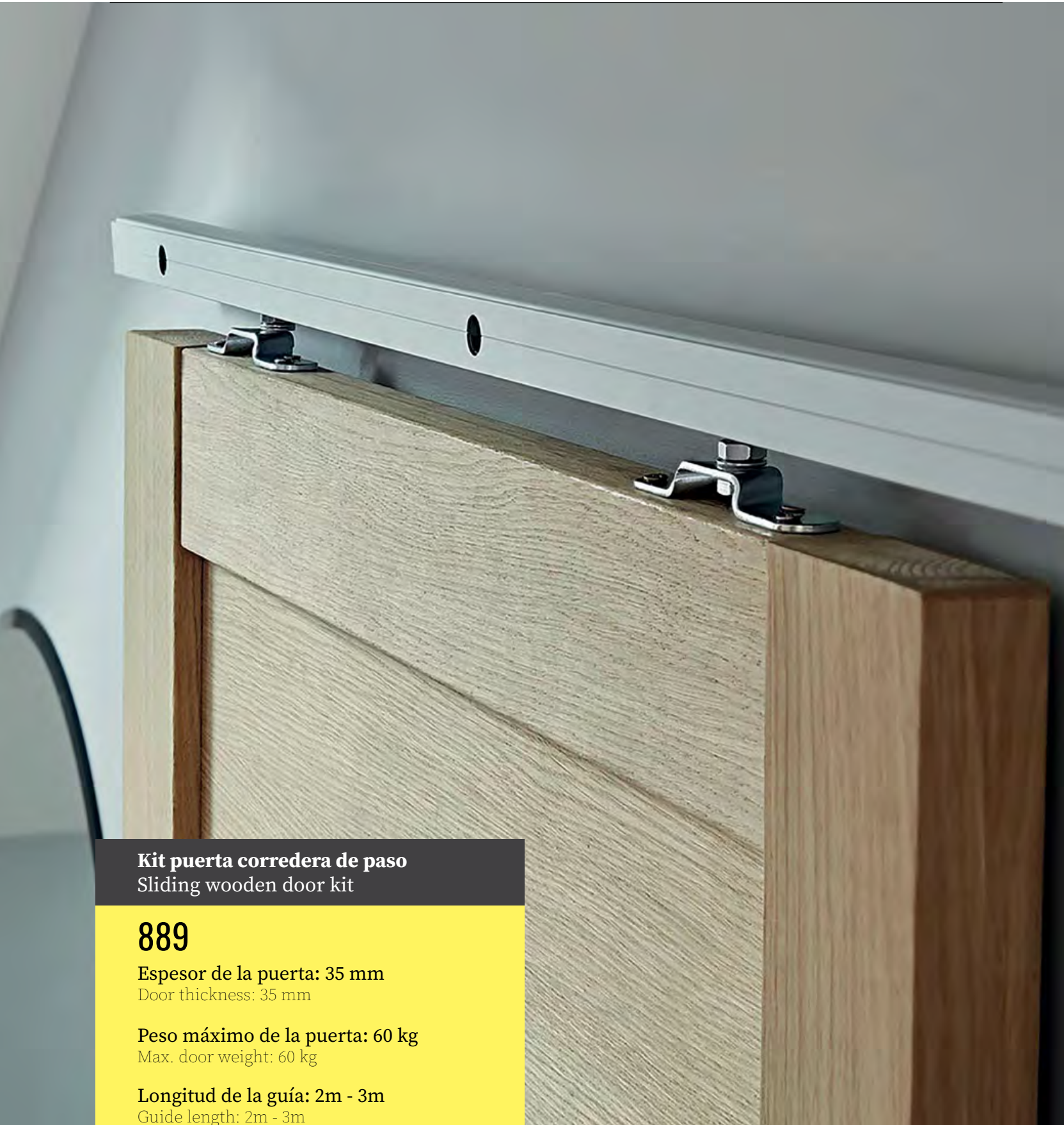

Kit puerta corredera de paso
Sliding wooden door kit

889

Espesor de la puerta: 35 mm
Door thickness: 35 mm

Peso máximo de la puerta: 60 kg
Max. door weight: 60 kg

Longitud de la guía: 2m - 3m
Guide length: 2m - 3m

CORREDERAS

Componentes del kit

Kit components

889



- 889.20.01 AC1 Kit puerta corredera con carril de 2 metros
Sliding door kit 2 meter long
- 889.30.01 AC1 Kit puerta corredera con carril de 3 metros
Sliding door kit 3 meter long
- 889.20.03 AC1 Juego de Embellecedores laterales para carril superior
Side cover for upper guide
- 889.20.04 AC1 Embellecedor frontal para carril superior 2 metros
2 meter front cover for upper guide
- 889.30.04 AC1 Embellecedor frontal para carril superior 3 metros
3 meter front cover for upper guide

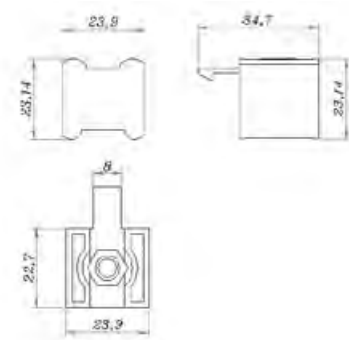
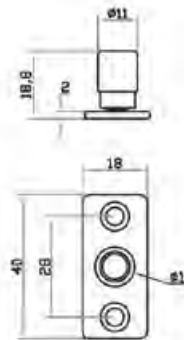
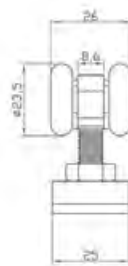
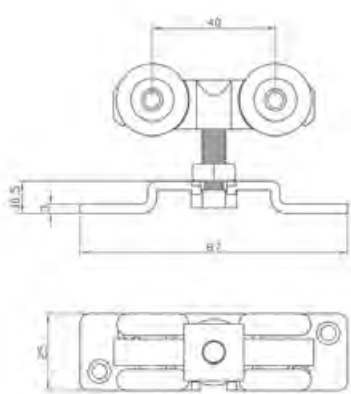

889.20.04 AC

Embellecedor frontal para carril superior 2 metros
2 meter front cover for upper guide

KITS PUERTAS

CORREDERAS



Kit puerta corredera de paso
Sliding wooden door kit

889S

Espesor de la puerta: 35 mm
Door thickness: 35 mm

Peso máximo de la puerta: 80 kg
Max. door weight: 80 kg

Longitud de la guía: 2 metros
Guide length: 2 meters

Incluye freno para cierre suave
Soft closing system included

CORREDERAS

Componentes del kit

Kit components

889S



889.20.01S AC1 Kit puerta corredera con freno con carril de 2 metros
Soft closing sliding door kit 2 meter long

889.20.04S AL1 Embellecedor frontal carril 2 metros
2 meter long front cover for upper guide

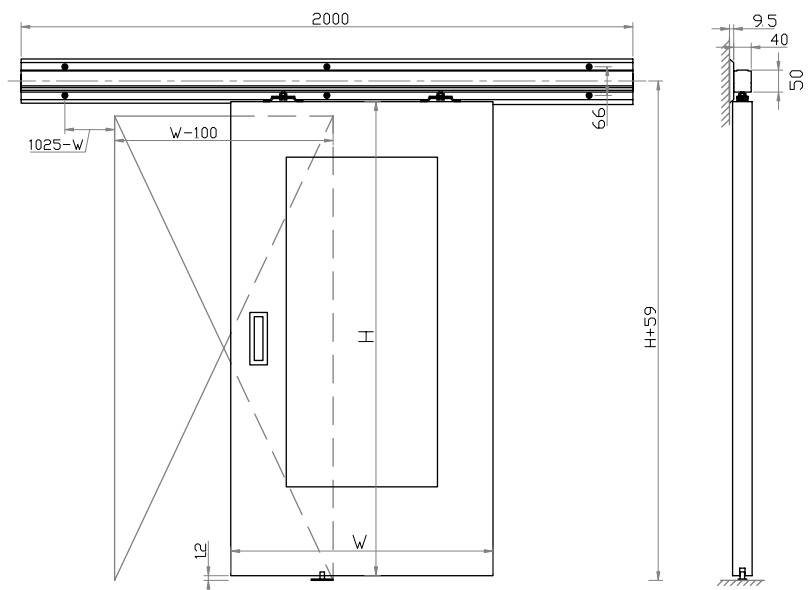

KITS PUERTAS

CORREDERAS



Kit puerta corredera de paso
Sliding wooden door kit

890

Espesor de la puerta: 35-45 mm
Door thickness: 35-45 mm

Peso máximo de la puerta: 80 kg
Max. door weight: 80 kg

Longitud de la guía: 2 y 3 metros
Guide length: 2 and 3 meters

Acabados disponibles: Negro y Blanco
Available finishes: Black and White

KITS PUERTAS CORREDERAS

Componentes del kit

Kit components

890

N	B	☐	
890.20.01 AC	890.20.01B AC1	Kit puerta corredera Rústico de 2 metros 2 meter long sliding door kit
890.30.01 AC	890.30.01B AC1	Kit puerta corredera Rústico de 3 metros 3 meter long sliding door kit
890.08.01 AC	-1	Freno para kit rústico 890/891 Soft closing system for barn door kit
890.21.01 AC	890.21.01B AC1	Kit adicional para puerta doble Supplementary barn door kit



890.08.01 AC

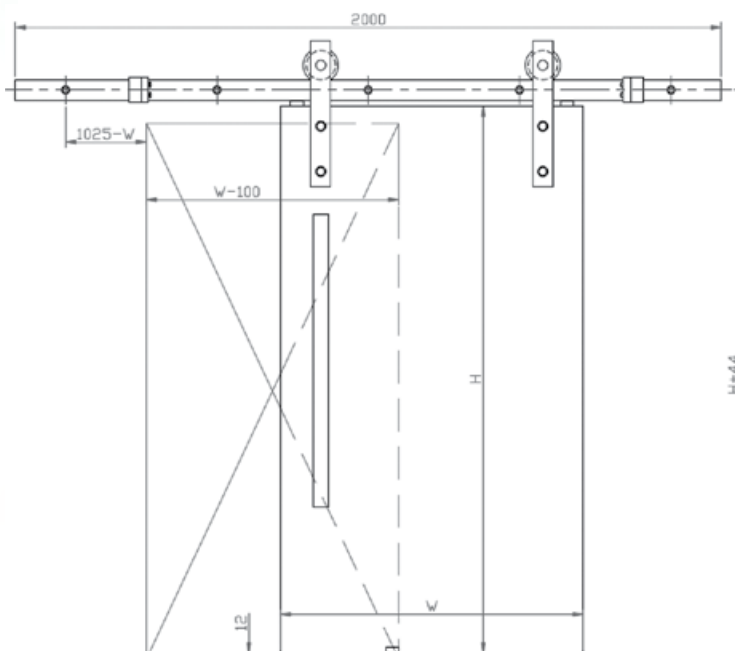

KITS PUERTAS

CORREDERAS



Kit puerta corredera de paso
Sliding wooden door kit

891

Espesor de la puerta: 35 mm
Door thickness: 35 mm

Peso máximo de la puerta: 80 kg
Max. door weight: 80 kg

Longitud de la guía: 2 y 3 metros
Guide length: 2 and 3 meters

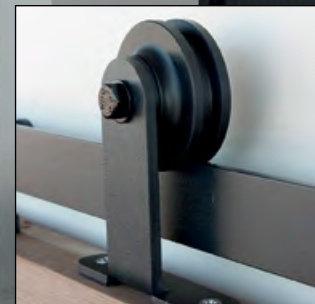

CORREDERAS

Componentes del kit

Kit components

891



891.20.01 AC1 Kit puerta corredera Rústico de 2 metros
2 meter long Black Colour Sliding door kit

891.30.01 AC1 Kit puerta corredera Rústico de 3 metros
3 meter long Black colour sliding door kit

890.08.01 AC1 Freno para kit rústico 890&891
Soft closing system for barn door kit

891.21.01 AC1 Kit adicional para puerta doble
Supplementary barn door kit

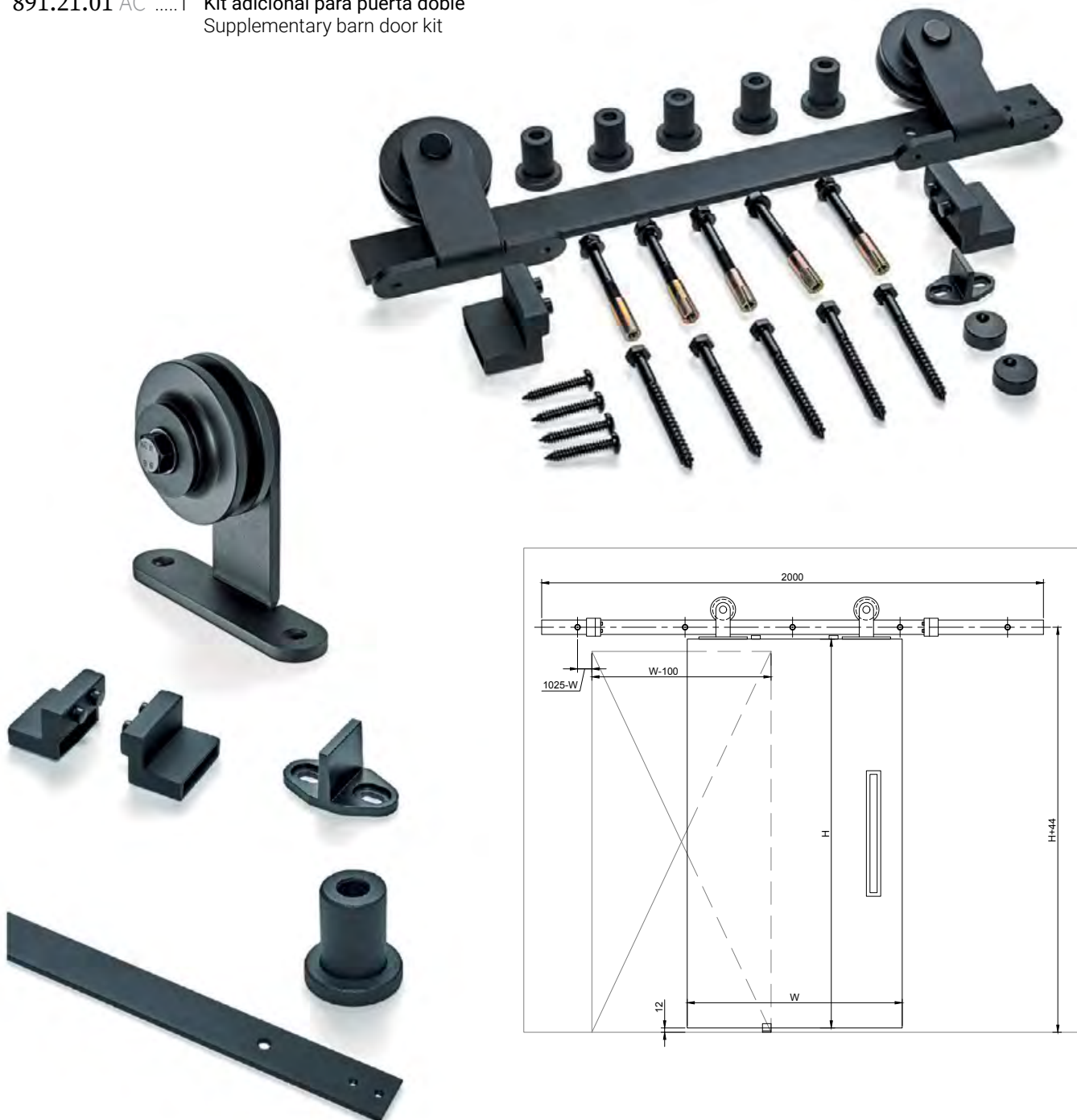

Mirilla
Door viewer

Z Zamak L Latón
Zamak Brass

Z

L

501.14 L 1.....20

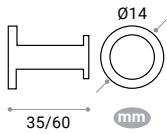

NS 501.14.01
PB 501.14.02
NSPB 501.14.05

504.14 Z 1.....12

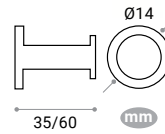

NS 504.14.01
PB 504.14.02
NSPB 504.14.05

505.14 Z 1.....20

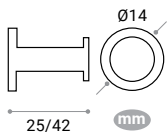

NS 505.14.01
PB 505.14.02
NSPB 505.14.05

506.14 Z 20.....100

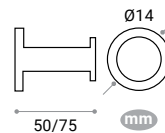

NSPB 506.14.05

***501.16** L 1.....20

Consultar disponibilidad
Available under request

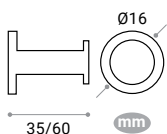

NS 501.16.01
NSPB 501.16.05

508.14 1.....30

Embellecedor de mirilla en NS y PB incluido
Door viewer cover in SN and PB included



NSPB 508.14.05

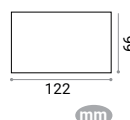

Tamaño de la pantalla/ Screen Size: 4 Pulgadas LCD
Ángulo de visión/ Viewing Angle: 120 grados
Sensor/Sensor: 2 Mega Pixel CMOS
Fuente de alimentación/Power supply: 3 baterías AAA
Peso Neto/ Net Weight: 220g
Espesor de la puerta/Door Thickness: 42-72mm; 68-95mm
Resolución de pantalla/Screen resolution: 800x480 px

SERIE INOXIDABLE

ACERO

IN Acero inoxidable L Latón
Stainless Steel Brass

Pomo
Door knob



1002.85 IN1.....50



IN 1002.85.01

1003.85 IN1.....50



N 1003.85.07



IN 1003.85.01



PVD 1003.85.08

1013.85 L1.....50



SAT 1013.85.02



PB 1013.85.03

1010.85 L1.....50



PB 1010.85.03



IN 1010.85.001



CS 1010.85.06

IN
L

HERRAJES PARA PUERTAS

Tope de puerta
Door stopper

Z Zamak IN Acero inoxidable
Zamak Stainless Steel

520.01 Z 25 100

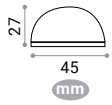

NS 520.01.01



SAT 520.01.02



PB 520.01.03

521.01 IN 25 100

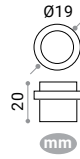

IN 521.01.01



520.02 Z 25 100

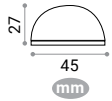

Adhesivo



N 520.02.07



B 520.02.13



NS 520.02.01



SAT 520.02.02



CS 520.02.06

522.01 Z 25 100

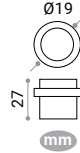

IN 522.01.01

Soporte pasamanos
Rail holder

1020.01 Z 4 40



N 1020.01.07



NS 1020.01.01



SAT 1020.01.02



PB 1020.01.03



CRS 1020.01.05



CS 1020.01.06

Picaporte tubular
Door latch



① **1055.45** 1 100

NS 1055.45.01
SAT 1055.45.02

② **1155.45** 1 100

NS 1155.45.01
SAT 1155.45.02
PB 1155.45.03

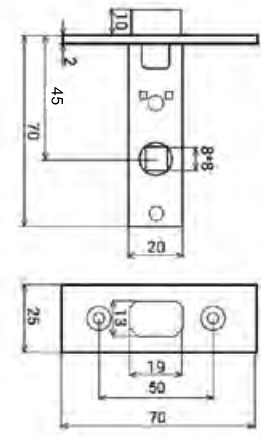
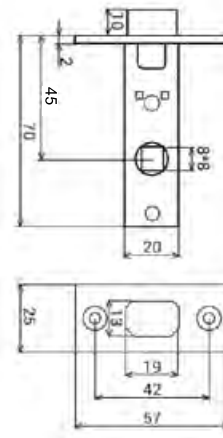

Picaporte tubular
Door latch

1055.60 1 100

NS 1055.60.01

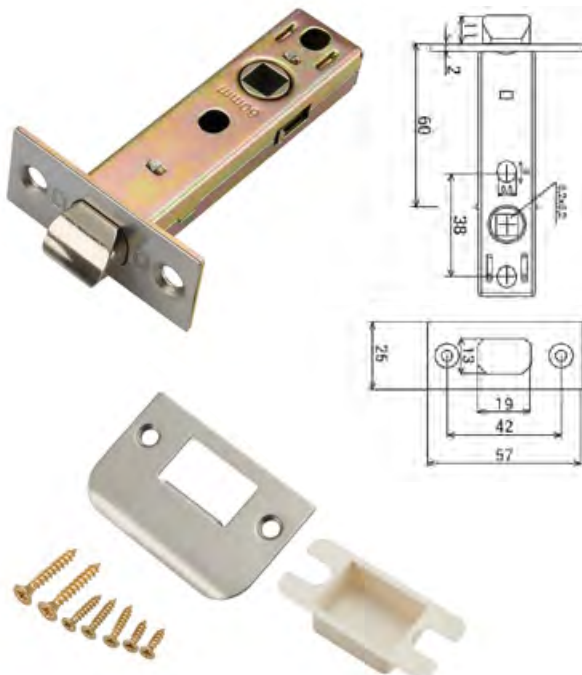

Picaporte condensa
Door latch

1056.45 1 100

NS 1056.45.01

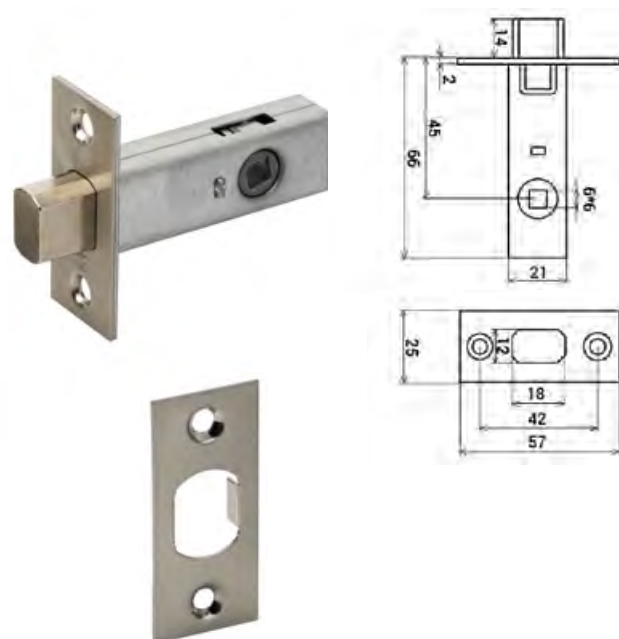

Picaporte unificado 47 x 50 mm

Body lock 47 x 50 mm

1050.4710100

NS 1050.47.01

SAT 1050.47.02

PB 1050.47.03

CS 1050.47.06

N 1050.47.07

BM 1050.47.23

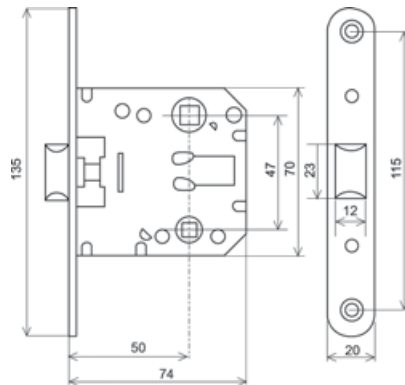
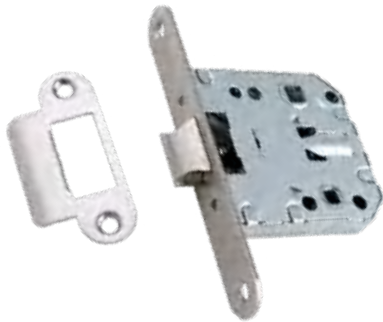

1050.47S10100

NS 1050.47.01S

SAT 1050.47.02S

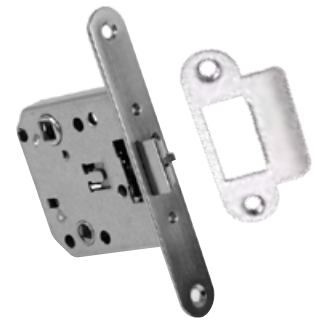

Picaporte unificado 70 x 50 mm

Body lock 70 x 50 mm

1050.70 150

NS 1050.70.01

SAT 1050.70.02

PB 1050.70.03

CS 1050.70.06

N 1050.70.07

BM 1050.70.23

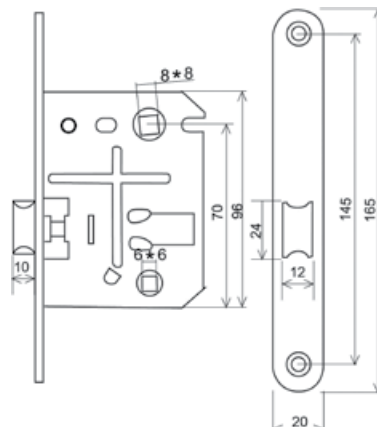

1050.70S150

NS 1050.70.01S

SAT 1050.70.02S



Cerradura de seguridad con bocallave "A" 47mm canto redondo

Mortise lock keyhole "A" 47 mm round front plate

1047.50 1 25

- NS** 1047.50.01
- SAT** 1047.50.02
- IN** 1047.50.001
- N** 1047.50.07

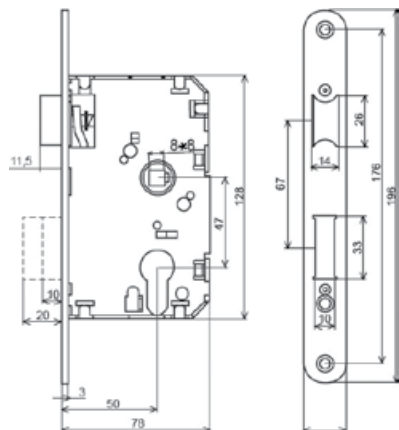

1047.60 1 20

- NS** 1047.60.01

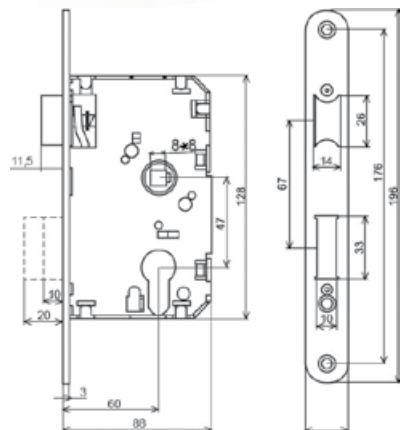

Cerradura de seguridad con bocallave "A" 47mm canto cuadrado

Mortise lock keyhole "A" 47 mm square front plate

1147.50 1 25

- NS** 1147.50.01
- SAT** 1147.50.02

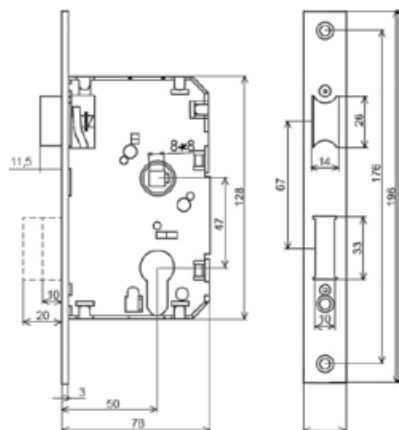

1147.60 1 20

- NS** 1147.60.01

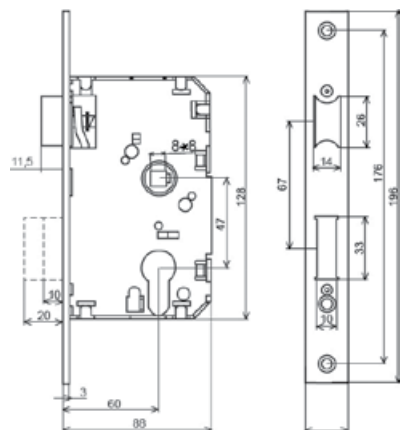



Cerradura de seguridad con bocallave "A" 70mm canto redondo

Mortise lock keyhole "A" 70 mm round front plate

1070.50  
.....1.....20

NS 1070.50.01

SAT 1070.50.02

IN 1070.50.001

N 1070.50.07

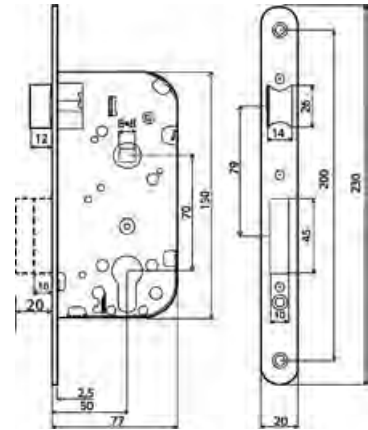

Cerradura de seguridad con bocallave "A" 70mm canto cuadrado

Mortise lock keyhole "A" 70 mm square front plate

1170.50  
..... 1 20

NS 1170.50.01

SAT 1170.50.02

IN 1170.50.001

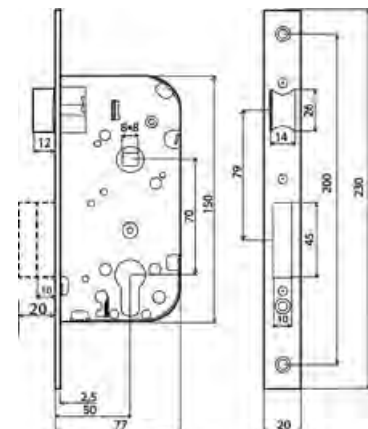

Cerradura de seguridad con bocallave "A" 85mm canto redondo

Mortise lock keyhole "A" 85 mm round front plate

1085.50 1 20

NS 1085.50.01

SAT 1085.50.02

IN 1085.50.001

N 1085.50.07

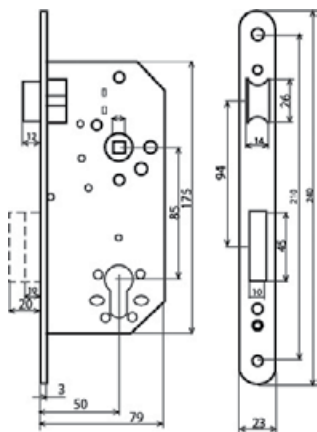

1085.60 1 20

NS 1085.60.01

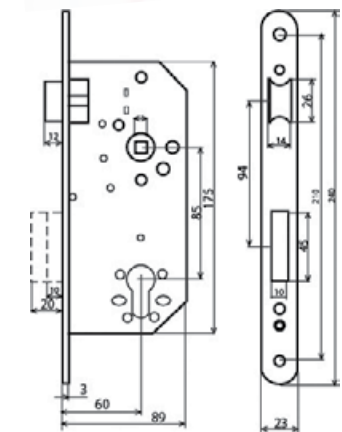

Cerradura de seguridad con bocallave "A" 85mm canto cuadrado

Mortise lock keyhole "A" 85 mm square front plate

1185.50 1 20

NS 1185.50.01

SAT 1185.50.02

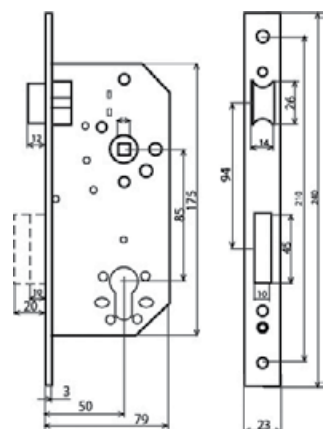

1185.60 1 20

NS 1185.60.01

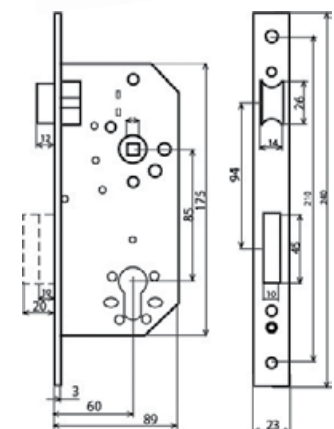

Bocallave plano

Escutcheon

1085.00



NS 1085.00.01

PB 1085.00.03

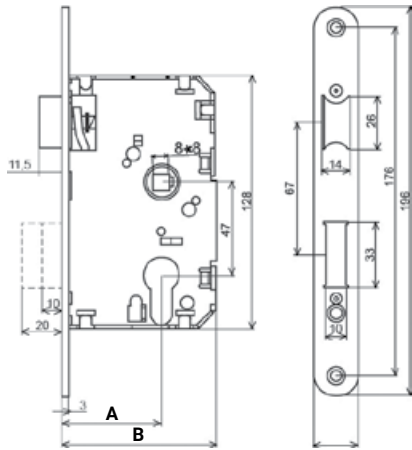

Cerradura de seguridad con bocallave "A" 47mm canto redondo y bombillo de seguridad 30/30

Mortise lock keyhole "A" 47mm round front plate and security cylinder 30/30

1047.511..... 25

NS 1047.51.01

SAT 1047.51.02

1047.611..... 20

NS 1047.61.01

Cerradura de seguridad con bocallave "A" 47mm canto redondo y bombillo serreta 30/30

Mortise lock keyhole "A" 47mm round front plate and cylinder 30/30

1047.521..... 25

NS 1047.52.01

SAT 1047.52.02

1047.621..... 20

NS 1047.62.01

1047.51 1047.61 1047.52 1047.62

A	50	60	50	60
B	78	88	78	88

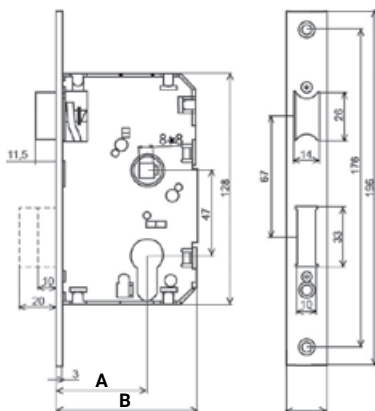

Cerradura de seguridad con bocallave "A" 47mm canto cuadrado y bombillo de seguridad 30/30

Mortise lock keyhole "A" 47mm square front plate and security cylinder 30/30

1147.511..... 25

NS 1147.51.01

SAT 1147.51.02

1147.611..... 20

NS 1147.61.01

Cerradura de seguridad con bocallave "A" 47mm canto cuadrado y bombillo serreta 30/30

Mortise lock keyhole "A" 47mm square front plate and cylinder 30/30

1147.521..... 25

NS 1147.52.01

SAT 1147.52.02

1147.621..... 20

NS 1147.62.01

1147.51 1147.61 1147.52 1147.62

A	50	60	50	60
B	78	88	78	88



Cerradura de seguridad con bocallave "A" 70mm canto redondo y bombillo de seguridad 30/30

Mortise lock keyhole "a" 70mm round front plate and security cylinder 30/30

1070.511..... 20

NS 1070.51.01

SAT 1070.51.02

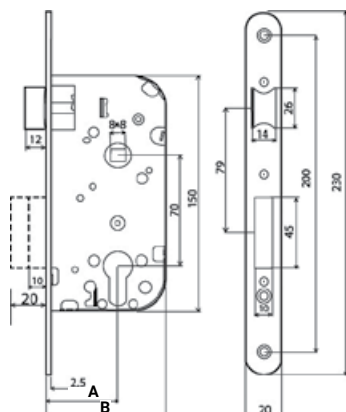

Cerradura de seguridad con bocallave "A" 70mm canto redondo y bombillo serreta 30/30

Mortise lock keyhole "a" 47mm round front plate and cylinder 30/30

1070.521..... 20

NS 1070.52.01

SAT 1070.52.02

1070.51 1070.52

A	50	50
B	77	77



Cerradura de seguridad con bocallave "A" 70mm canto cuadrado y bombillo de seguridad 30/30

Mortise lock keyhole "A" 70mm square front plate and security cylinder 30/30

1170.511..... 20

NS 1170.51.01

SAT 1170.51.02

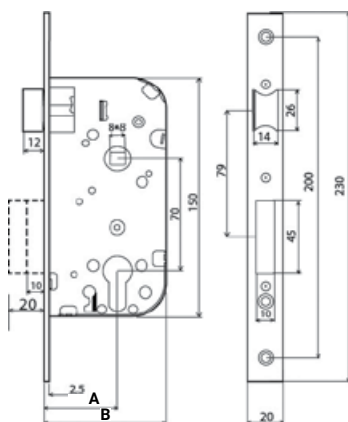

Cerradura de seguridad con bocallave "A" 70mm canto cuadrado y bombillo serreta 30/30

Mortise lock keyhole "A" 47mm square front plate and cylinder 30/30

1170.521..... 20

NS 1170.52.01

SAT 1170.52.02

1170.51 1170.52

A	50	50
B	77	77

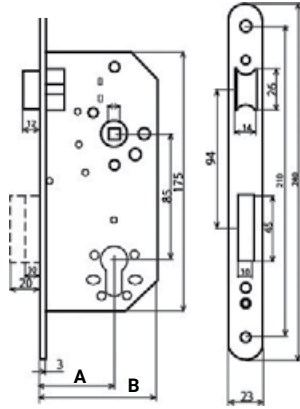

1085.51 1085.61 1085.52 1085.62

A	50	60	50	60
B	79	89	79	89

Cerradura de seguridad con bocallave "A" 85mm canto redondo y bombillo de seguridad 30/30

Mortise lock keyhole "A" 85mm round front plate and security cylinder 30/30

1085.511..... 20

NS 1085.51.01

SAT 1085.51.02

1085.611..... 20

NS 1085.61.01

Cerradura de seguridad con bocallave "A" 85mm canto redondo y bombillo serreta 30/30

Mortise lock keyhole "A" 85mm round front plate and cylinder 30/30

1085.521..... 20

NS 1085.52.01

SAT 1085.52.02

1085.621..... 20

NS 1085.62.01

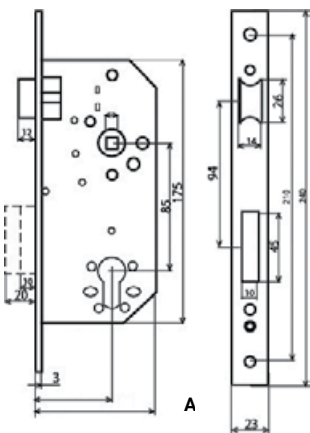

1185.51 1185.61 1185.52 1185.62

A	50	60	50	60
B	79	89	79	89

Cerradura de seguridad con bocallave "A" 85mm canto cuadrado y bombillo de seguridad 30/30

Mortise lock keyhole "A" 85mm square front plate and security cylinder 30/30

1185.511..... 20

NS 1185.51.01

SAT 1185.51.02

1185.611..... 20

NS 1185.61.01

Cerradura de seguridad con bocallave "A" 85mm canto cuadrado y bombillo serreta 30/30

Mortise lock keyhole "A" 85mm square front plate and cylinder 30/30

1185.521..... 20

NS 1185.52.01

SAT 1185.52.02

1185.621..... 20

NS 1185.62.01



Cerradura de seguridad 4 bulones con bocallave "A" 85 mm

Mortise lock 4 bolts keyhole "A" 85 mm

Canto recto
Square front

Canto redondo
Round front

1185.50 4B1.... 20

1085.50 4B1.... 20

NS 1185.50.4B.01

NS 1085.50.4B.01

SAT 1185.50.4B.02

SAT 1085.50.4B.02

N 1185.50.4B.07

N 1085.50.4B.07

IN 1185.50.4B.001

IN 1085.50.4B.001

ESC 10851.... 50

BOC 10851.... 50



NS ESC1085.01

NS BOC1085.01

SAT ESC1085.02

SAT BOC1085.02

N ESC1085.07

N BOC1085.07

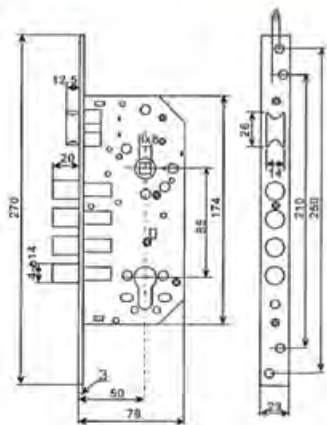

Cerradura/ Picaporte magnético con bocallave "A" 72 mm

Magnetic lock 72 x 50 mm



1072.50.01M1.... 50

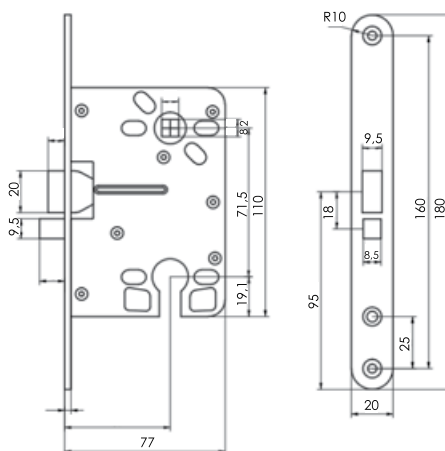

- Cerradura Magnética Unificada para puerta de paso.
- Incluye convertor a condena.
- Cajeadado de hierro en acabado NEGRO.
- Frontal y Cerradero fabricados en Zamak.
- Entrada 50mm.
- Distancia entre ejes 72mm.
- Disponible en Níquel Satinado.
- Fabricado en Zamak.
- Tornillo M5 x 55mm.
- Posibilidad de ser suministrada individualmente.

Convertor bocallave a condena

Bathroom converter

1072.00.00

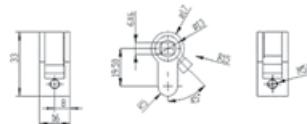



Cilindro serreta latón 30/30 con 5 llaves

Brass cylinder 30/30 with 5 keys

L Latón
Brass

L



1040.01 L1.....100

NS 1040.01.01

PB 1040.01.03

Cilindro serreta latón 20/20 con 3 llaves

Brass cylinder 20/20 with 3 keys



1040.02 L1.....100

NS 1040.02.01

PB 1040.02.03

Cilindro seguridad latón 30/30 con 5 llaves

Brass security cylinder 30/30 with 5 keys



1041.11 L10.....100

NS 1041.11.01

SAT 1041.11.02

Cilindro seguridad 30/30 con 5 llaves

Security cylinder 30/30 with 5 keys

Z Zamak
Zamak



1041.01 Z  10.....100

NS 1041.01.01

SAT 1041.01.02

Z

HERRAJES PARA PUERTAS

Cilindro seguridad 35/35 con 5 llaves

Security cylinder 35/35 with 5 keys



1041.03 Z  10.....100

NS 1041.03.01

SAT 1041.03.02

Cilindro seguridad 30/40 con 5 llaves

Security cylinder 30/40 with 5 keys



1041.04 Z  10.....100

NS 1041.04.01

SAT 1041.04.02



Cilindros serreta con 5 llaves

Cylinders with 5 keys

Z



medidas

30/30

1042.01 Z10.....100

NS 1042.01.01

SAT 1042.01.02



medidas

35/35

1042.03 Z10.....100

NS 1042.03.01

SAT 1042.03.02



medidas

30/40

1042.04 Z10.....100

NS 1042.04.01

SAT 1042.04.02



medidas

40/40

1042.05 Z10.....100

NS 1042.05.01

Cilindro serreta 30/30 **Leva Corta** con 5 llaves

Short cam cylinder 30/30 with 5 keys



30/30

1042.01 LC Z10.....100

NS 1042.01.01 LC

SAT 1042.01.02 LC

Pernios acero inoxidable

Stainless steel H-Hinge

IN Acero inoxidable
Stainless Steel

101.01 IN  20.....200

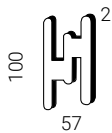

DERECHA RIGHT

 101.01.01

IZQUIERDA LEFT

 101.01.02

IN

HERRAJES PARA PUERTAS

Bisagras acero inoxidable canto redondo

Stainless steel round corner flat Hinge

107.90 IN  10.....100

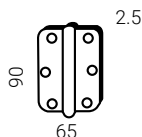

DERECHA RIGHT

 107.90.01

IZQUIERDA LEFT

 107.90.02

Bisagras acero inoxidable canto cuadrado

Stainless steel straight corner flat Hinge

108.90/ 108.80 IN  10.....100

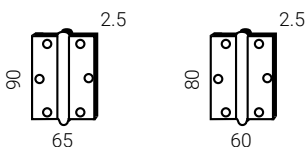



DERECHA RIGHT

 108.90.01

 108.80.01

IZQUIERDA LEFT

 108.90.02

 108.80.02

Bisagra acero inoxidable

Stainless steel flat hinge

109.90 IN  10.....100

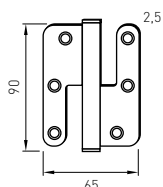

DERECHA RIGHT

 109.90.01

IZQUIERDA LEFT

 109.90.02

AC

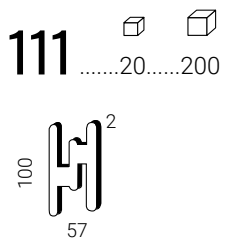

- DERECHA RIGHT
- IN 111.01.01
 - SAT 111.02.01
 - PB 111.03.01
 - CS 111.06.01
 - N 111.07.01
 - B 111.13.01

- IZQUIERDA LEFT
- IN 111.01.02
 - SAT 111.02.02
 - PB 111.03.02
 - CS 111.06.02
 - N 111.07.02
 - B 111.13.02

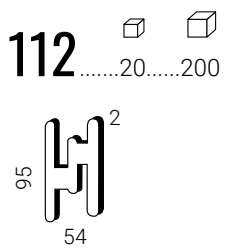

- DERECHA RIGHT
- IN 112.01.01
 - SAT 112.02.01
 - PB 112.03.01
 - CS 112.06.01
 - N 112.07.01
 - B 112.13.01

- IZQUIERDA LEFT
- IN 112.01.02
 - SAT 112.02.02
 - PB 112.03.02
 - CS 112.06.02
 - N 112.07.02
 - B 112.13.02

Bisagras canto redondo
Round corner flat hinge

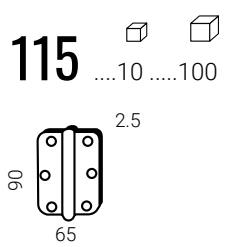

- DERECHA RIGHT
- NS 115.01.01
 - SAT 115.02.01
 - N 115.07.01
 - B 115.13.01

- IZQUIERDA LEFT
- NS 115.01.02
 - SAT 115.02.02
 - N 115.07.02
 - B 115.13.02

Bisagras canto cuadrado
Straight corner flat hinge

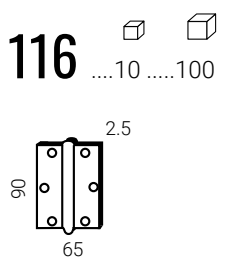

- DERECHA RIGHT
- NS 116.01.01
 - SAT 116.02.01
 - N 116.07.01
 - B 116.13.01

- IZQUIERDA LEFT
- NS 116.01.02
 - SAT 116.02.02
 - N 116.07.02
 - B 116.13.02

Bisagra de seguridad 150x80 R16 canto redondo

Security hinge 150x80, R16 round corner

AC Acero
Steel

12010.....40

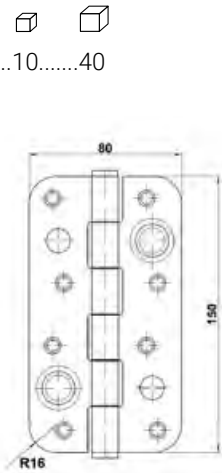

- NS** 120.01.01
- PB** 120.03.01
- N** 120.07.01

AC

HERRAJES PARA PUERTAS

Bisagra de seguridad 150x80 canto recto

Security hinge 150x80 straight corner

12110.....40

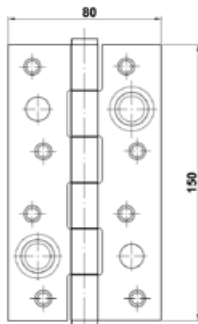

- NS** 121.01.01
- N** 121.07.01

Pasadores puerta

Door bolts

130.1620.....200

Pasador para puerta de 160 mm

Door bolt - 160 mm



- NS** 130.16.01
- SAT** 130.16.02

130.2020.....200

Pasador para puerta de 200 mm

Door bolt - 200 mm



- NS** 130.20.01
- SAT** 130.20.02

SERIE
CABINAS 



Bisagra con muelle para cabina
Spring hinge for sanitary cabin

Bisagra para cabina
Hinge for sanitary cabin

IN Acero inoxidable
Stainless Steel

870.90 IN  
.....10.....100

871.90 IN  
.....10.....100



IN

HERRAJES PARA PUERTAS

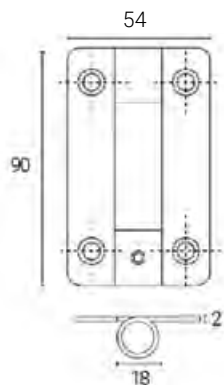

IN 870.90.01

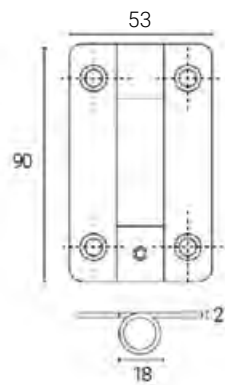

IN 871.90.01

Pata regulable en altura 100/180
Adjustable feet - height 100/180

Pinza unión lateral
Clamp side union

872.01 IN  
.....4.....40

873.01 IN  
.....30.....240



Soporte suelo - tablero.
Con Roseta y tornillos ocultos
Apta para tablero de 13mm
Feet leg. With hidden screws
Suitable for 13mm board frame.

Apta para tablero de 13mm
Suitable for 13mm board frame.

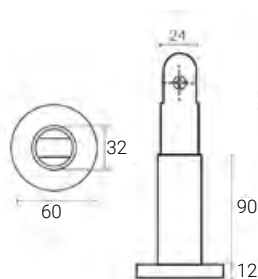

IN 872.01.01 h=100-180mm
872.02.01 h=130-200mm

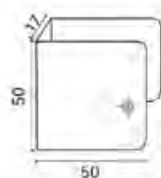

IN 873.01.01



Perfil en "U" "U" profile

IN Acero inoxidable
Stainless Steel

873.03 IN  
.....1.....25

1800x15x20 mm



IN





 873.03.01

Perfil en "L" interior "L" in profile

873.04 IN  
.....1.....25

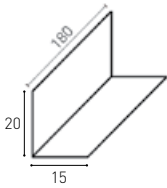
1800x15x20 mm





 873.04.01

Perfil en "L" exterior "L" out profile

873.05 IN  
.....1.....25

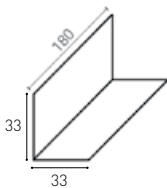
1800x33x33 mm



 873.05.01

Escuadra de sujeción
Mounting bracket

Pinza "T-U" unión
Support to wall "T-U"

IN Acero inoxidable
Stainless Steel

873.02 IN  10.....240

51x51x50x2 mm

Escuadra de unión a 90°
90° union

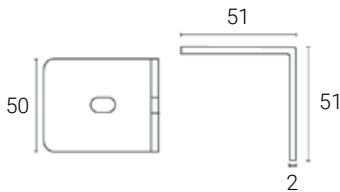

IN 873.02.01

873.06 IN  1.....25

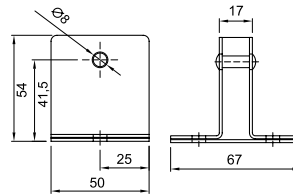

IN 873.06.01

IN

HERRAJES PARA PUERTAS

Soporte tubo - pared
Tube wall connector

874.01 IN  10.....100

Soporte con tornillos ocultos
para fijación de Tubo a la pared.
Support with hidden mounting
screws to assemble the wall Tube.

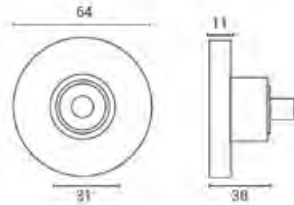

IN 874.01.01

Percha con tope de puerta
Hanger with door stop

883.01 IN  10.....200

73x80x2 mm

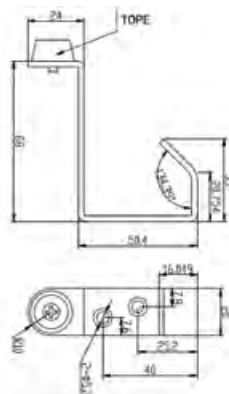

IN 883.01.01



Nudo de conexión 2 entradas a 90°

Knot connection 2 inputs 90°

IN Acero inoxidable
Stainless Steel

874.02 IN  6.....60



Apta para tubo de 25mm de diámetro.
Suitable for 25mm diameter tube.

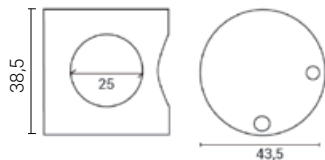

IN 874.02.01

Nudo de conexión 3 entradas a 180°

Knot connection 3 inputs 180°

874.03 IN  5.....50



Apta para tubo de 25mm de diámetro.
Suitable for 25mm diameter tube.

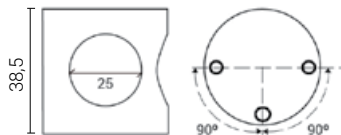

IN 874.03.01

Pinza unión tubo - pared

Union pipe clamp

874.04 IN  30.....240



1800x15x20 mm

Apta para tableros de 13mm.
Suitable for 13mm board frame.

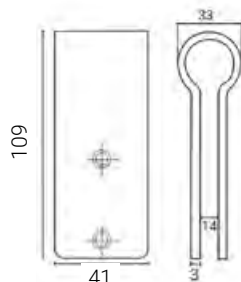

IN 874.04.01

Unión para tubo 25mm
25 mm tube connector

Tubo para cabinas sanitarias
Upper tube

IN Acero inoxidable
Stainless Steel

874.05 IN20.....300

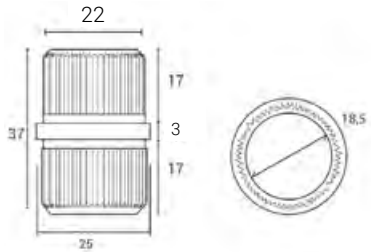

IN 874.05.01

875.01 IN1.....1

3000x1,5 mm / Ø25mm



IN 875.01.01



IN

HERRAJES PARA PUERTAS

Condena y desbloqueo con indicador
Turn and release knob with indicator

Juego de pomos
Door knob

881.53 IN1.....100

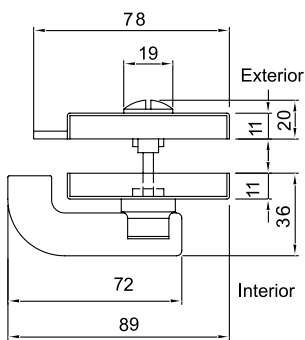

IN 881.53.01

882.25 IN10.....50

Ø25mm

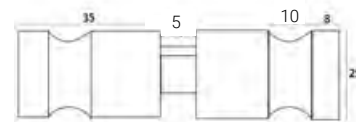

IN 882.25.01



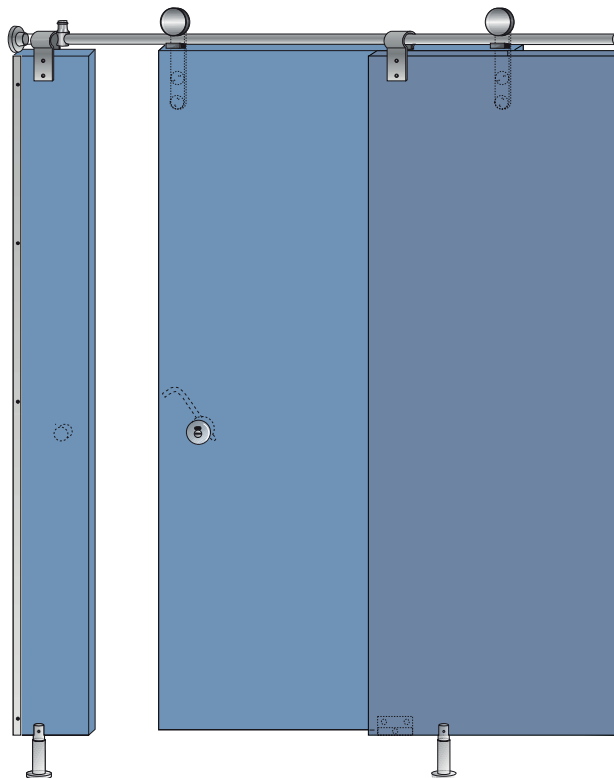

Kit puerta corredera para cabina sanitaria

Sliding door kit for sanitary cabin

IN Acero inoxidable
Stainless Steel

888.00 IN 1



IN 888.00.01

Condena y emergencia tubular

Tubular turn and release

880.53 IN  1.....50



IN 880.53.01

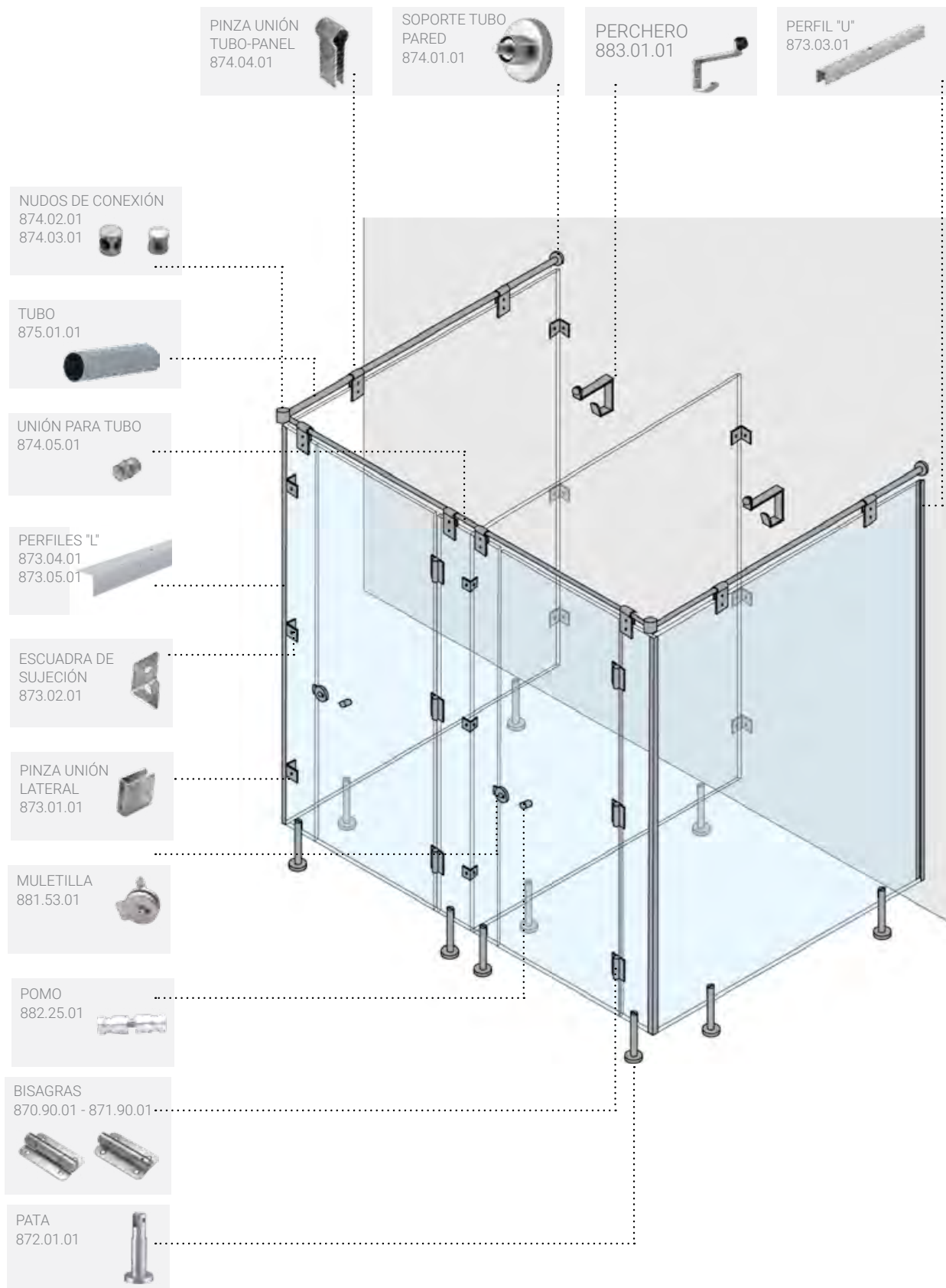



HERRAJES PARA MUEBLES, COCINA Y ARMARIO

182-189 **GUÍAS PARA CAJONES**
Drawer slides



190-206 **BISAGRAS PARA COCINAS**
Cabinet hinges



207-219 **SISTEMA DE CAJÓN 220**
Soft closing drawer slide



220-229 **SISTEMA DE CAJÓN LIGHTBOX**
LightBox soft closing drawer slide

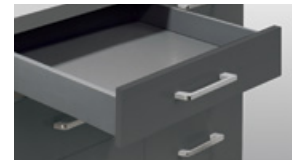

230-242 **HERRAJES FUNCIONALES PARA COCINA**
Kitchen storage and organization



243-249 **ELEVABLES PARA PUERTAS DE COCINA**
Gas lifter for cabinet



250-251 **HERRAJES PARA ARMARIOS**
Wardrobe hardware



252-259 **POMOS Y TIRADORES PARA PUERTAS DE COCINA Y MUEBLE**
Cabinet knobs and handles





HERRAJES PARA MUEBLES



GUÍA 200

GUÍA DE CAÍDA
RUNNER SLIDES

GUÍA 200

B **MR** **GP**

(01) Blanco *White* RAL 9010
(02) Marrón *Brown* RAL 8014
(03) Gris Plata *Silver Grey* RAL 9006

- Montaje del cajón con tornillos
Assembled with screws
- Las guías se sirven emparejadas y en cajas de 25 uds
Items are sold paired 25 pcs/box
- Capacidad de carga 20 kg
Load Capacity: 20 kg



SERIE SERIE	COD. COLOR			TAMAÑO		mm	📦
	B	MR	GP	SIZE			
200	01	02	03	25	250	25	
	01	02	03	30	300	25	
	01	02	03	35	350	25	
	01	02	03	40	400	25	
	01	02	03	45	450	25	
	01	02	03	50	500	25	
	01	02	03	55	550	25	
	01	02	03	60	600	25	

FRENO PARA GUÍAS METÁLICAS

Soft closing for runner slides

SERIE	CÓDIGO		📦
200	00	01	400

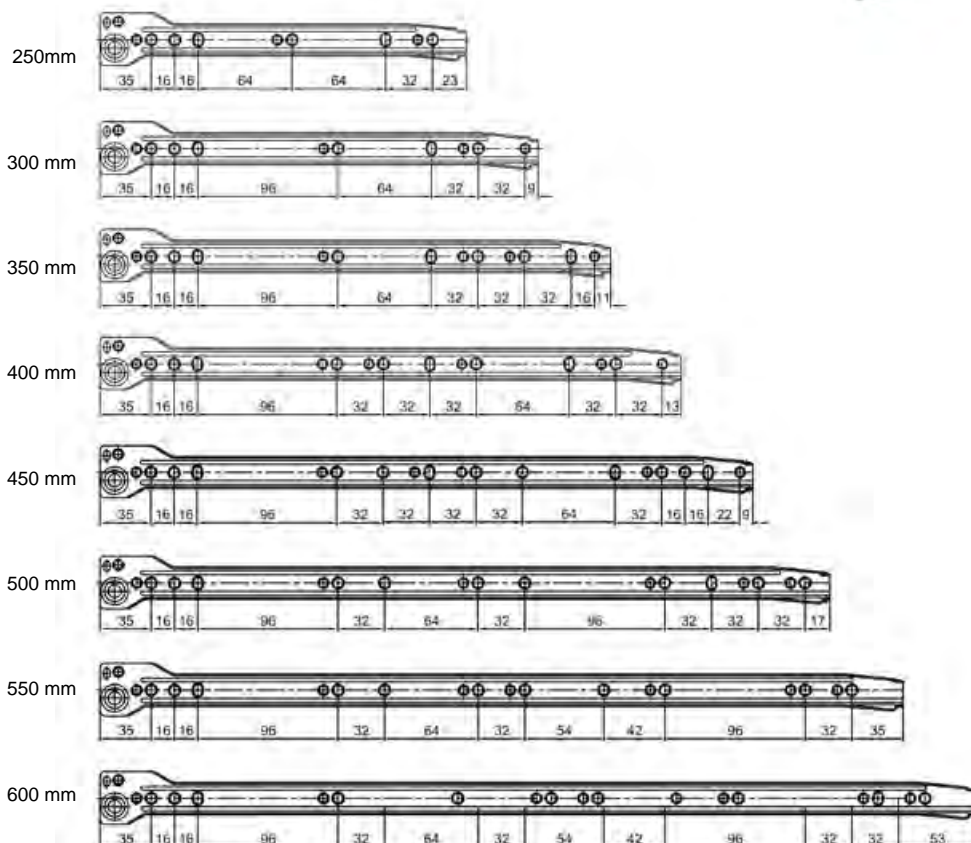

GUÍA 205

Hierro zincado
Galvanized sheet



GUÍA DE BOLAS CON EXTRACCIÓN TOTAL
BALL BEARING SLIDE. FULL EXTENSION

GUÍA 205

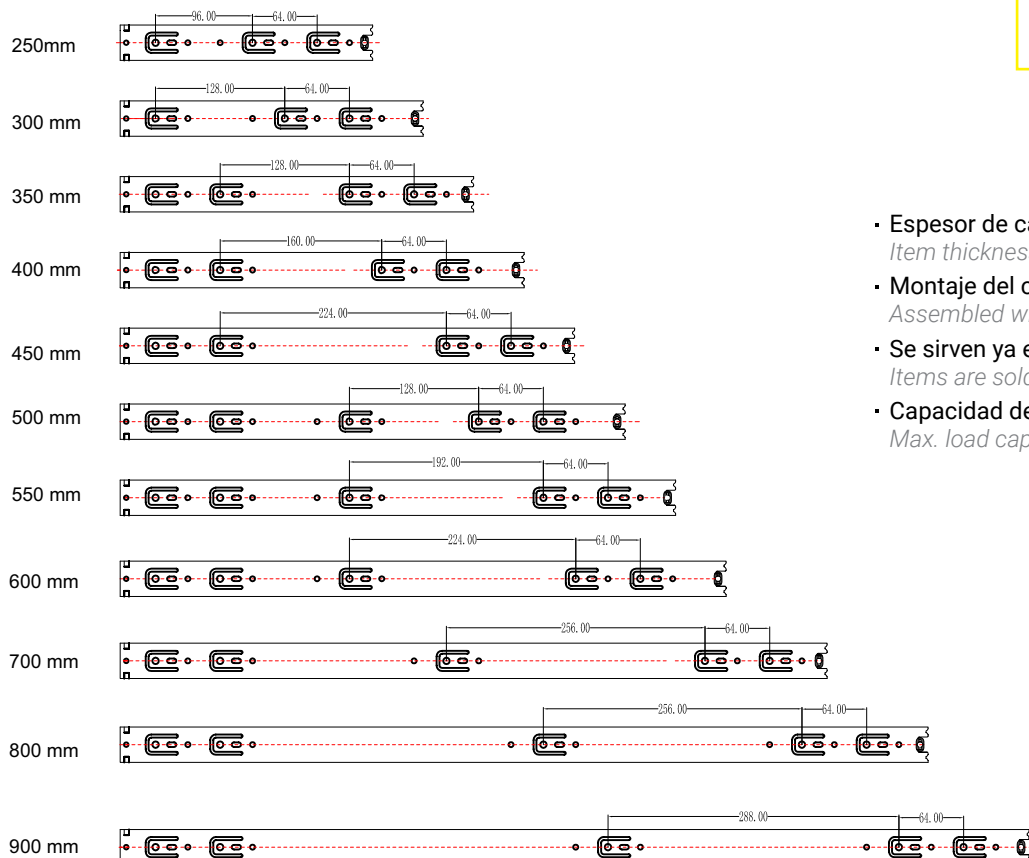
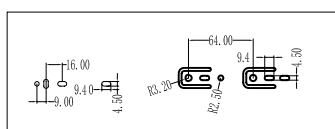

SERIE	CÓDIGO	mm	📦
205	01 25	250	15
	01 30	300	15
	01 35	350	15
	01 40	400	10
	01 45	450	10
	01 50	500	10
	01 55	550	10
	01 60	600	10
	01 70	700	10
	01 80	800	10
01 90	900	10	

- Espesor de cada hoja: 1,2 x 1,2 x 1,5 mm
Item thickness: 1.2 x 1.2 x 1.5 mm
- Montaje del cajón con tornillos
Assembled with screws
- Se sirven ya emparejadas
Items are sold paired
- Capacidad de carga 45 kg
Max. load capacity: Up to 45 kg

GUÍA 207

Hierro zincado
Galvanized sheet



GUÍA DE BOLAS CON EXTRACCIÓN TOTAL Y FRENO
SOFT CLOSING BALL BEARING SLIDES

GUÍA 207

SERIE	CÓDIGO	mm	
207	01 25	250	15
	01 30	300	15
	01 35	350	15
	01 40	400	10
	01 45	450	10
	01 50	500	10
	01 55	550	10
	01 60	600	10

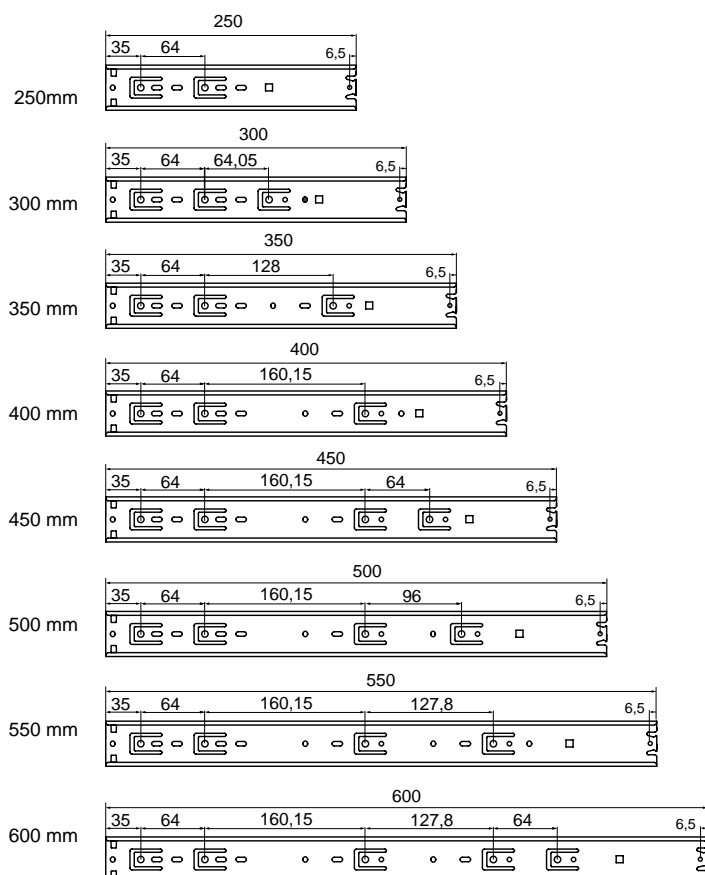

- Espesor de cada hoja: 1,0 x 1,0 x 1,2 mm
Item thickness: 1.0 x 1.0 x 1.2 mm
- Montaje del cajón con tornillos
Assembled with screws
- Guía desmontable a través de un gatillo
Easy to disassembly with a trigger
- Se sirven ya emparejadas
Items are sold paired
- Capacidad de carga 45 kg
Max. load capacity: Up to 45 kg

GUÍA 210/001

Hierro zincado
Galvanized sheet



GUÍA CUADRO DE EXTRACCIÓN TOTAL CON CIERRE SUAVE SOFT CLOSING CONCEALED SLIDE

GUÍA 210/001

- Espesor de cada hoja: 1,8 x 1,5 x 1,0 mm
Item thickness: 1.8 x 1.5 x 1.0 mm
- Montaje del cajón con tornillos
Assembled with screws
- Se sirven ya emparejadas
Items are sold paired
- Incorpora pistón de amortiguación
With height adjust screw
- Capacidad de carga 30 kg
Max. load capacity: Up to 30 kg

SERIE	CÓDIGO	mm	mm
210	001 30	300	10
	001 35	350	10
	001 40	400	10
	001 45	450	10
	001 50	500	10
	001 55	550	10

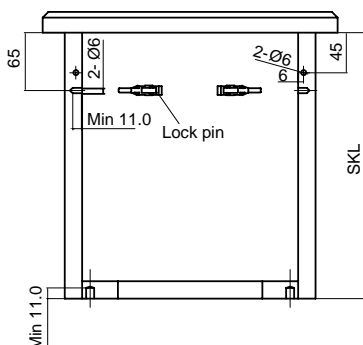
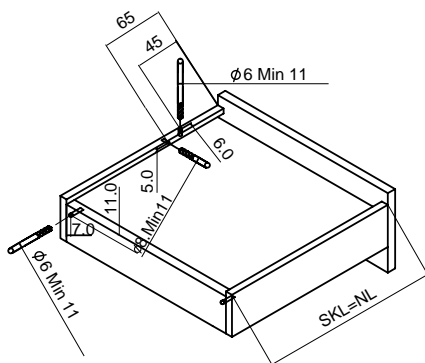

NL: longitud de la guía
SKL: longitud del panel lateral

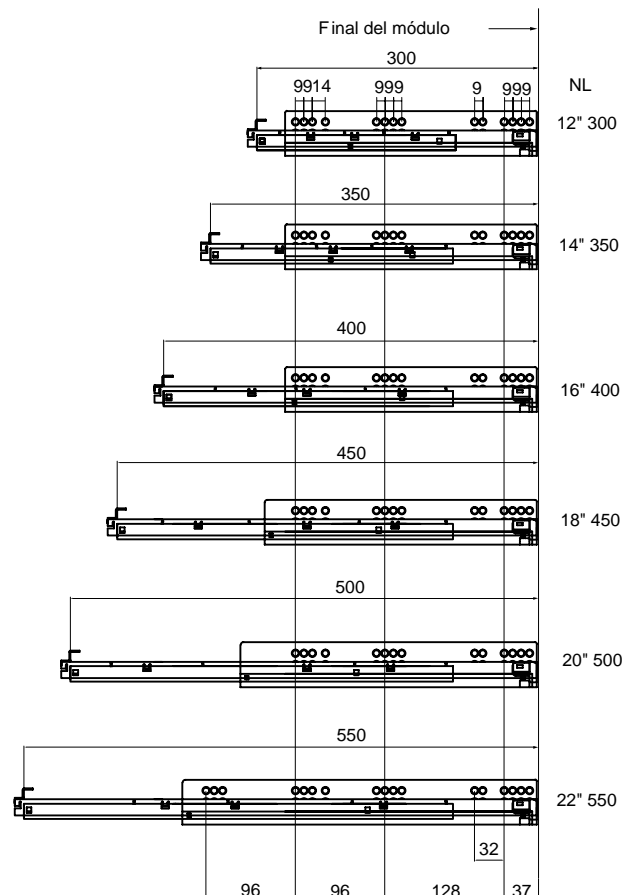

GUÍA 210/002

Hierro zincado
Galvanized sheet



GUÍA CON EXTRACCIÓN TOTAL Y CIERRE SUAVE SOFT CLOSING CONCEALED SLIDE

GUÍA 210/002

- Espesor de cada hoja: 1,8 x 1,5 x 1,0 mm
Item thickness: 1.8 x 1.5 x 1.0 mm
- Montaje del cajón con tornillos
Assembled with screws
- Incluye pinzas de bloqueo
With lock-unlock device
- Se sirven ya emparejadas
Items are sold paired
- Incorpora pistón de amortiguación
With height adjust screw
- Capacidad de carga 30 kg
Max. load capacity: Up to 30 kg

SERIE	CÓDIGO	mm	📦
210	002 30	300	10
	002 35	350	10
	002 40	400	10
	002 45	450	10
	002 50	500	10
	002 55	550	10

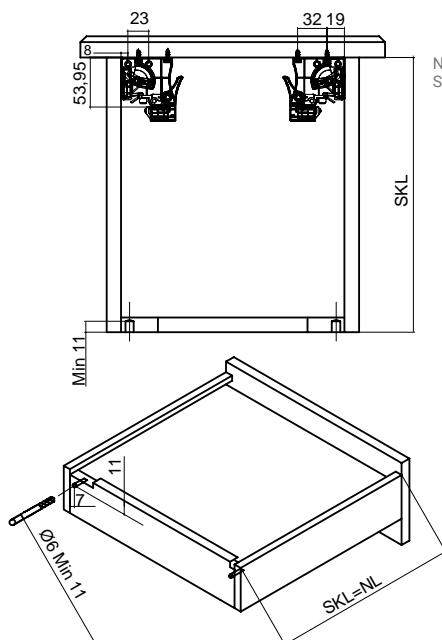

NL: longitud de la guía
SKL: longitud del panel lateral

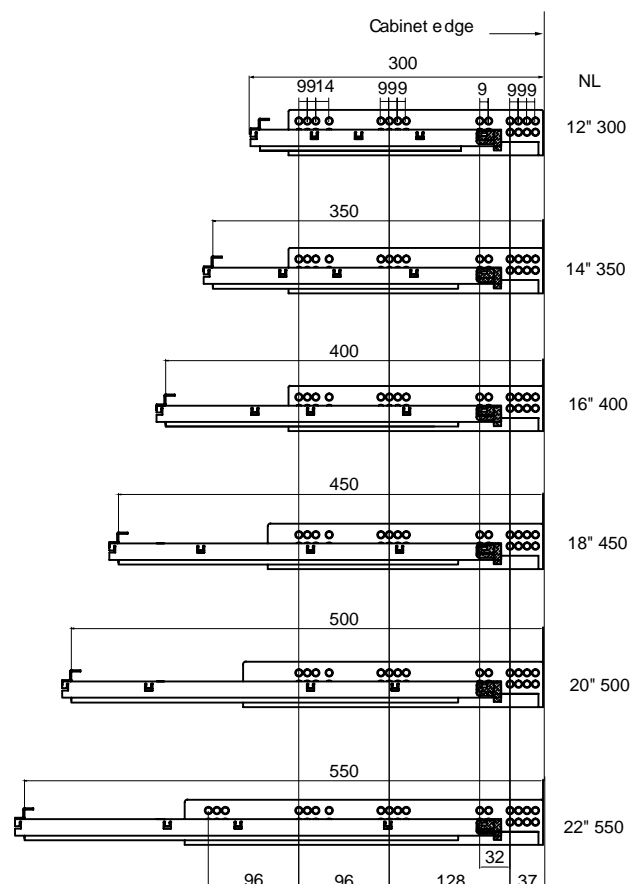

GUÍA 211

Herro zincado
Galvanized sheet



GUÍA CUADRO DE EXTRACCIÓN TOTAL CON PUSH PUSH TO OPEN CONCEALED DRAWER SLIDE

GUÍA 211

- Espesor de cada hoja: 1,8 x 1,5 x 1,0 mm
Item thickness: 1.8 x 1.5 x 1.0 mm
- Montaje del cajón con tornillos
Assembled with screws
- Incluye pivote de bloqueo
With height adjust screw
- Se sirven ya emparejadas
Items are sold paired
- Incorpora pistón de amortiguación
With height adjust screw
- Capacidad de carga 30 kg
Max. load capacity: Up to 30 kg

SERIE	CÓDIGO	mm	mm
211	01 30	300	10
	01 35	350	10
	01 40	400	10
	01 45	450	10
	01 50	500	10
	01 55	550	10

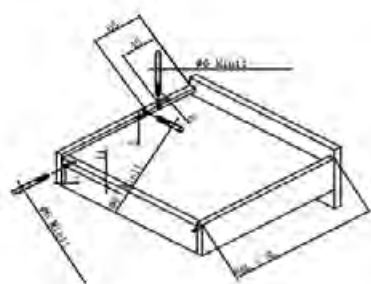

SEW= Anchura del cajón
NL= Longitud Nominal de la guía

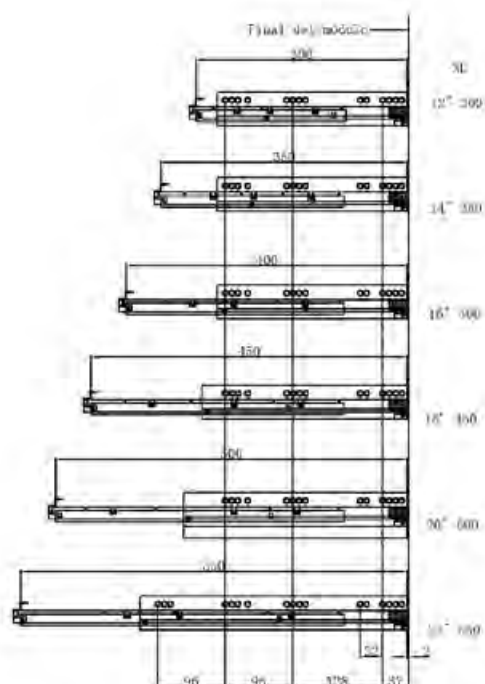
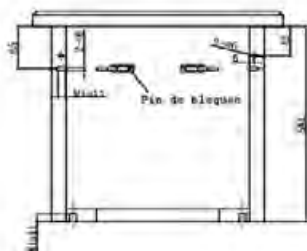

GUÍA 212

Hierro zincado
Galvanized sheet



GUÍA CUADRO:
DE EXTRACCIÓN PARCIAL Y CIERRE SUACE
SINGLE EXTRACTION CONCEALED DRAWER SLIDE

GUÍA 212

- Espesor de cada hoja: 1,5 x 1,5 mm
Item thickness: 1.5 x 1.5 mm
- Montaje del cajón con tornillos
Assembled with screws
- Permite la extracción parcial del cajón
It allows a partial extraction
- Incluye pivote de bloqueo
With height adjust screw
- Se sirven ya emparejadas
Items are sold paired
- Incorpora pistón de amortiguación
With height adjust screw
- Capacidad de carga 30 kg
Max. load capacity: Up to 30 kg

SERIE	CÓDIGO	mm	📦
212	01 30	300	10
	01 35	350	10
	01 40	400	10
	01 45	450	10
	01 50	500	10
	01 55	550	10

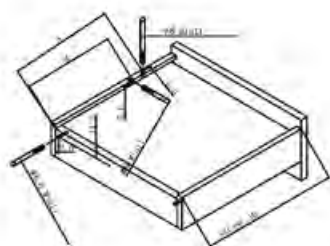

Módulo de fijación en la pared
Módulo de fijación del cajón

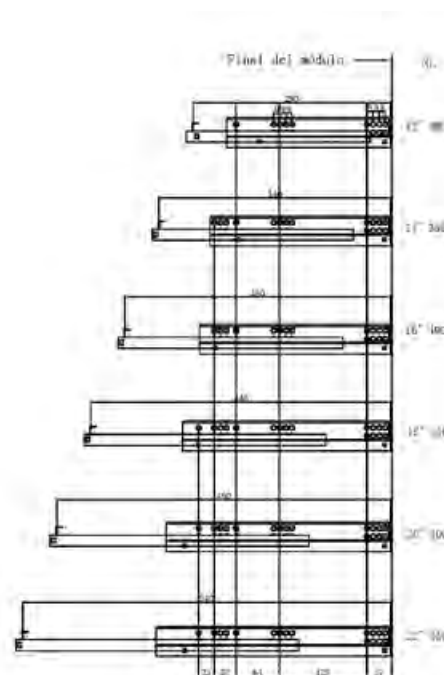
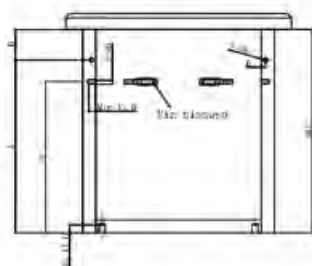

300 26



SERIE	CÓDIGO	
300	26 01	200
	26 02	200
	26 03	200

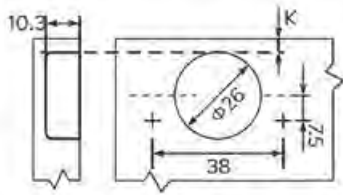

- Ángulo de apertura 95°
Opening angle: 95°
- Profundidad de la cazoleta: 11.3mm
Depth of hinge cup: 11.3mm
- Diámetro de la cazoleta: 26mm
Diameter of hinge cup: 26mm
- Material: Hierro con baño de Níquel
Material: Iron with nickel plating



300 26 01
Recta *Full overlay*

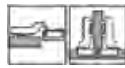
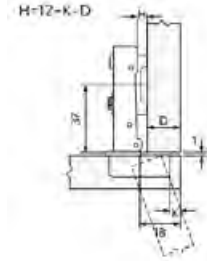

300 26 02
Acodada *Half overlay*



300 26 03
Súper acodada *Inset*



Recta *Full overlay*



Acodada *Half overlay*



Súper acodada *Inset*



301 35



SERIE	CÓDIGO	📦
301	35 01	200
	35 02	200
	35 03	200

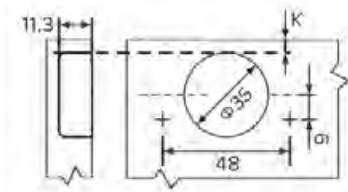

- Ángulo de apertura 110°
Opening angle: 110°
- Profundidad de la cazoleta: 11.3mm
Depth of hinge cup: 11.3mm
- Diámetro de la cazoleta: 35mm
Diameter of hinge cup: 35mm
- Material: Hierro con baño de Níquel
Material: Iron with nickel plating
- Sistema de montaje de la base: CLIP
Plate fixed with clip system



301 35 01
Recta *Full overlay*

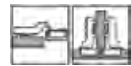
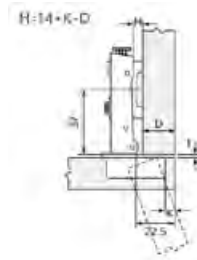

301 35 02
Acodada *Half overlay*



301 35 03
Súper acodada *Inset*



Recta *Full overlay*



Acodada *Half overlay*



Súper acodada *Inset*



305 35



SERIE	CÓDIGO	📦
305	35 01	100
	35 02	100
	35 03	100

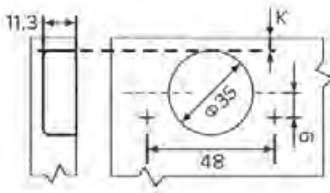

- Ángulo de apertura 110°
Opening angle 110°
- Profundidad de la cazoleta: 11.3 mm
Depth of hinge cup: 11.3mm
- Diámetro de la cazoleta: 35 mm
Diameter of hinge cup: 35mm
- Material: Hierro con baño de Níquel
Material: Iron with nickel plating



305 35 01
Recta *Full overlay*

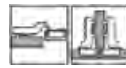
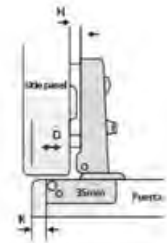

305 35 02
Acodada *Half overlay*

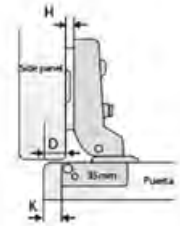

305 35 03
Súper acodada *Inset*

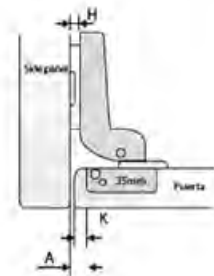

Recta *Full overlay*



Acodada *Half overlay*



Súper acodada *Inset*



306 35



SERIE	CÓDIGO	📦
306	35 01	100
	35 02	100
	35 03	100

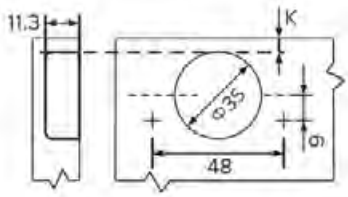

- **Base ajustable**
Adjustable plate
- **Ángulo de apertura 165°**
Opening angle: 165°
- **Profundidad de la cazoleta: 11.3mm**
Depth of hinge cup: 11.3mm
- **Diámetro de la cazoleta: 35mm**
Diameter of hinge cup: 35mm
- **Material: Hierro con baño de Níquel**
Material: Iron with nickel plating
- **Sistema de montaje de la base: CLIP**
Plate fixed with clip system



306 35 01
Recta *Full overlay*



$H=14+K-D$

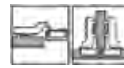
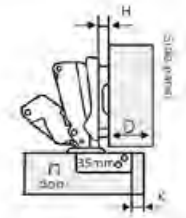

306 35 02
Acodada *Half overlay*



$H=4+K-D$

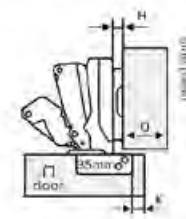

306 35 03
Súper acodada *Inset*



$H=3+K+A$

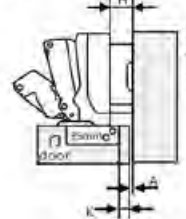

Recta *Full overlay*



Acodada *Half overlay*



Súper acodada *Inset*



BISAGRA CLIP CON FRENO
CLIP-ON HINGE WITH
SOFT CLOSING SYSTEM

306 55

AC Acero
 Steel

306 55

AC



306 55 01
 Recta Full overlay

SERIE	CÓDIGO	
306	55 01	100

- **Bisagra tipo CLIP**
Clip-On hinge
- **Base ajustable**
Adjustable plate
- **Ángulo de apertura 165°**
Opening angle: 165°
- **Profundidad de la cazoleta: 11.5mm**
Depth of hinge cup: 11.5mm
- **Diámetro de la cazoleta: 35mm**
Diameter of hinge cup: 35mm
- **Material: Hierro con baño de Níquel**
Material: Iron with nickel plating
- **Sistema de montaje de la base: CLIP**
Plate fixed with clip system

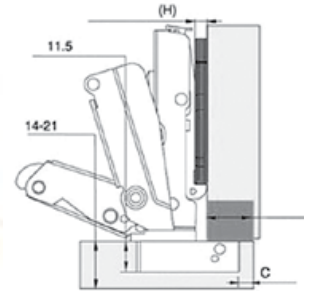

BISAGRA DE CAZOLETA
CONCEALED HINGE

307 35

AC Acero
 Steel

307 35

AC



307 35 01
 135°

SERIE	CÓDIGO	
307	35 01	200

- **Bisagra tipo CLIP**
Clip-On hinge
- **Base ajustable**
Adjustable plate
- **Ángulo de apertura 135°**
Opening angle: 135°
- **Profundidad de la cazoleta: 11.3mm**
Depth of hinge cup: 11.3mm
- **Diámetro de la cazoleta: 35mm**
Diameter of hinge cup: 35mm
- **Material: Hierro con baño de Níquel**
Material: Iron with nickel plating

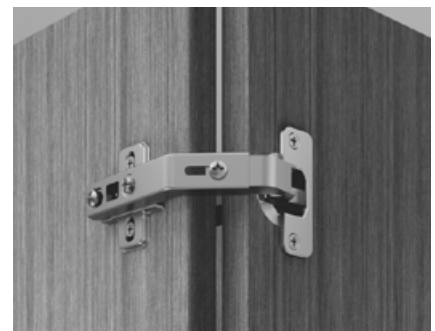
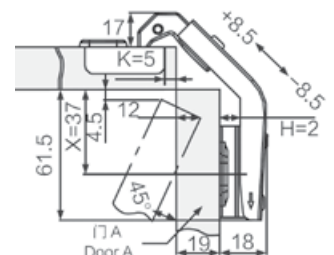

BISAGRA DE CAZOLETA
CONCEALED HINGE

308 35

AC Acero
Steel

308 35

 308 35 01
90°

AC

SERIE	CÓDIGO	
308	35 01	100

- **Base ajustable**
Adjustable plate
- **Ángulo de apertura 90°**
Opening angle: 90°
- **Profundidad de la cazoleta: 11.3mm**
Depth of hinge cup: 11.3mm
- **Diámetro de la cazoleta: 35mm**
Diameter of hinge cup: 35mm
- **Material: Hierro con baño de Níquel**
Material: Iron with nickel plating
- **Sistema de montaje de la base: CLIP**
Plate fixed with clip system

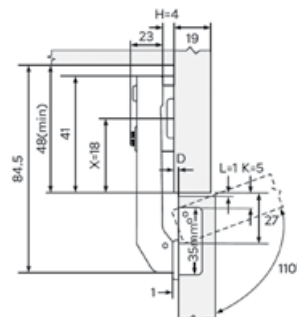

HERRAJES PARA MUEBLES

BISAGRA CLIP CON FRENO
CLIP-ON HINGE WITH
SOFT CLOSING SYSTEM

308 55

AC Acero
Steel

308 55

 308 55 01
90°



AC

SERIE	CÓDIGO	
308	55 01	200

- **Bisagra con freno**
Soft closing Clip-On hinge
- **Base ajustable**
Adjustable plate
- **Ángulo de apertura 90°**
Opening angle: 90°
- **Profundidad de la cazoleta: 11.3mm**
Depth of hinge cup: 11.3mm
- **Diámetro de la cazoleta: 35mm**
Diameter of hinge cup: 35mm
- **Material: Hierro con baño de Níquel**
Material: Iron with nickel plating
- **Sistema de montaje de la base: CLIP**
Plate fixed with clip system

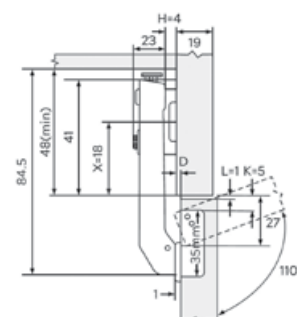

BISAGRA CLIP
CLIP-ON HINGE WITH
ADJUSTABLE PLATE

309 35

AC Acero
Steel

309 35

AC

SERIE	CÓDIGO	
309	35 01	200

- **Bisagra tipo CLIP**
Clip-On hinge
- **Base ajustable**
Adjustable plate
- **Ángulo de apertura 45°**
Opening angle: 45°
- **Profundidad de la cazoleta: 11.3mm**
Depth of hinge cup: 11.3mm
- **Diámetro de la cazoleta: 35mm**
Diameter of hinge cup: 35mm
- **Material: Hierro con baño de Níquel**
Material: Iron with nickel plating
- **Sistema de montaje de la base: CLIP**
Plate fixed with clip system

 **309 35 01**
45°

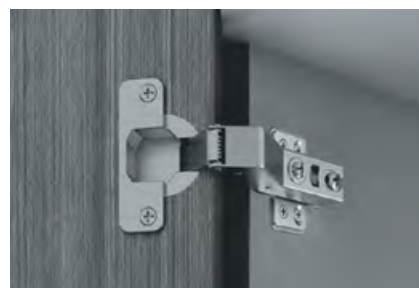
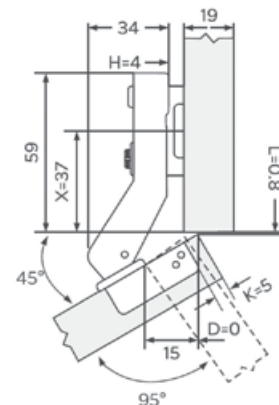

BISAGRA CLIP CIERRE SUAVE
CLIP-ON HINGE WITH
SOFT CLOSING SYSTEM

309 55

AC Acero
Steel

309 55

AC

SERIE	CÓDIGO	
309	55 01	200

- **Base ajustable**
Adjustable plate
- **Ángulo de apertura 45°**
Opening angle: 45°
- **Profundidad de la cazoleta: 11.3mm**
Depth of hinge cup: 11.3mm
- **Diámetro de la cazoleta: 35mm**
Diameter of hinge cup: 35mm
- **Material: Hierro con baño de Níquel**
Material: Iron with nickel plating
- **Sistema de montaje de la base: CLIP**
Plate fixed with clip system



 **309 55 01**
45°

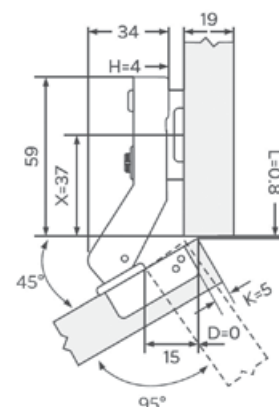

310 35

AC



SERIE	CÓDIGO		
310	35 01	10	100
	35 02	10	100
	35 03	10	100

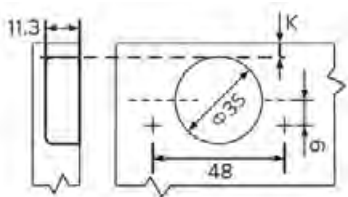

- **Base ajustable**
Adjustable plate
- **Cierre suave**
Soft closing type
- **Ángulo de apertura 95-110°**
Opening angle: 165°
- **Profundidad de la cazoleta: 12mm**
Depth of hinge cup: 12mm
- **Diámetro de la cazoleta: 35mm**
Diameter of hinge cup: 35mm
- **Material: Hierro con baño de Níquel**
Material: Iron with nickel plating
- **Sistema de montaje de la base: CLIP**
Plate fixed with clip system
- **Apta para tableros de 16-19mm**
Suitable for 16-19mm board frame



310 35 01
Recta *Full overlay*

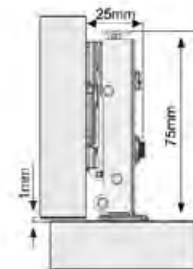

310 35 02
Acodada *Half overlay*

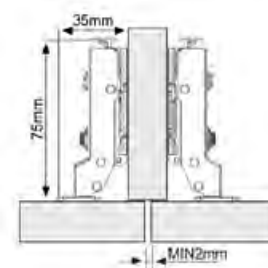

310 35 03
Súper acodada *Inset*

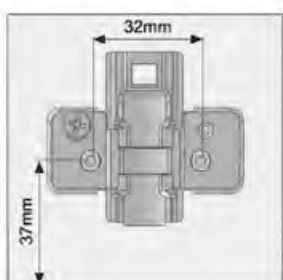
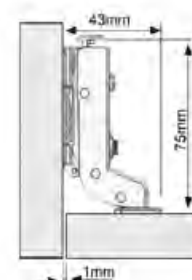

BISAGRA CLIP CON FRENO
CLIP-ON HINGE WITH
SOFT CLOSING SYSTEM

311 35

AC Acero
 Steel

311 35

AC

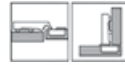

311 35 01
 Recta Full overlay

SERIE	CÓDIGO		
311	35 01	10	100

- Cierre suave
Soft closing type
- Ángulo de apertura 95-110°
Opening angle: 165°
- Profundidad de la cazoleta: 12mm
Depth of hinge cup: 12mm
- Diámetro de la cazoleta: 35mm
Diameter of hinge cup: 35mm
- Distancia entre tornillos en la cazoleta: 48mm. Con tetón M10
Hole to hole distance on hinge cup: 48mm. Includes M10 Dowel
- Material: Hierro con baño de Níquel
Material: Iron with nickel plating
- Sistema de montaje de la base: CLIP
Plate fixed with clip system
- Apta para tableros de 16-19mm
Suitable for 16-19mm board frame

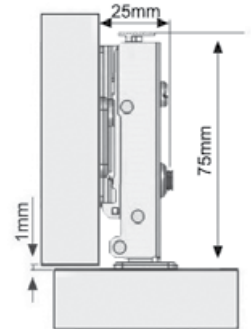

BISAGRA DE CAZOLETA
CONCEALED HINGE

312 35

AC Acero
 Steel

312 35

AC



312 35 01
 Recta Full overlay

SERIE	CÓDIGO		
312	35 01	10	100

- Cierre suave
Soft closing type
- Ángulo de apertura 95-110°
Opening angle: 165°
- Profundidad de la cazoleta: 12mm
Depth of hinge cup: 12mm
- Diámetro de la cazoleta: 35mm
Diameter of hinge cup: 35mm
- Distancia entre tornillos en la cazoleta: 52mm. Con tetón M10
Hole to hole distance on hinge cup: 52mm. Includes M10 Dowel
- Material: Hierro con baño de Níquel
Material: Iron with nickel plating
- Sistema de montaje de la base: CLIP
Plate fixed with clip system
- Apta para tableros de 16-19mm
Suitable for 16-19mm board frame

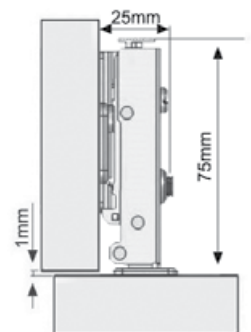

313 35

AC



313 35 01

Recta Full overlay

SERIE	CÓDIGO	
313	35 01	100
	35 02	100
	35 03	100

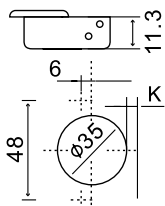

HERRAJES PARA MUEBLES

- Cierre suave CON FRENO
Soft closing type
- Ángulo de apertura 105°
Opening angle: 105°
- Profundidad de la cazoleta: 11.3mm
Depth of hinge cup: 11.3mm
- Diámetro de la cazoleta: 35mm
Diameter of hinge cup: 35mm
- Bisagra con ajustes 3D con excéntrica
3D adjustments
- Distancia entre tornillos en la cazoleta: 48mm
Hole to hole distance on hinge cup: 48mm
- Material: Hierro con baño de Níquel
Material: Iron with nickel plating
- Sistema de montaje de la base: CLIP
Plate fixed with clip system

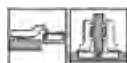

313 35 02

Acodada Half overlay



Accesorios Accessories



Ref. 316 CC



Ref. 316 CB



313 35 03

Súper acodada Inset



313 35

AC



313 35 1

Recta Full overlay

SERIE	CÓDIGO	📦
313	35 1	100
	35 2	100
	35 3	100

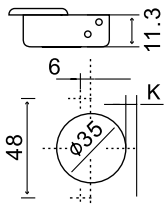

- **Cierre suave**
Soft closing type
- **Ángulo de apertura 105°**
Opening angle: 105°
- **Profundidad de la cazoleta: 11.3mm**
Depth of hinge cup: 11.3mm
- **Diámetro de la cazoleta: 35mm**
Diameter of hinge cup: 35mm
- **Bisagra con ajustes 3D con excéntrica**
3D adjustments
- **Distancia entre tornillos en la cazoleta: 48mm**
Hole to hole distance on hinge cup: 48mm
- **Material: Hierro con baño de Níquel**
Material: Iron with nickel plating
- **Sistema de montaje de la base: CLIP**
Plate fixed with clip system



313 35 2

Acodada Half overlay

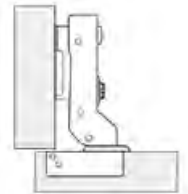

313 35 3

Súper acodada Inset



Accesorios Accessories



Ref. 316 CC



Ref. 316 CB

313...

AC



313 45 01/ 313 48 01/ 313 52 01

Recta Full overlay

SERIE CÓDIGO

SERIE	CÓDIGO	CANTIDAD	
313	45 01	48 01	100
		48 02	100
	48 01	52 01	100
		52 02	100
	48 03	52 03	100

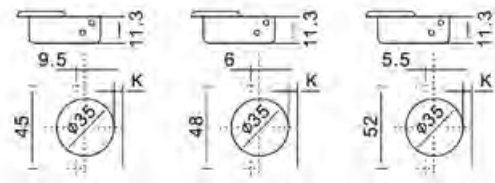

- Cierre suave
Soft closing type
- Ángulo de apertura 105°
Opening angle: 105°
- Profundidad de la cazoleta: 11.3mm
Depth of hinge cup: 11.3mm
- Diámetro de la cazoleta: 35mm
Diameter of hinge cup: 35mm
- Bisagra con ajustes 3D con excéntrica
3D adjustments
- Distancia entre tornillos en la cazoleta:
45mm, 48mm ó 52mm
*Hole to hole distance on hinge cup:
45mm, 48mm or 52mm*
- Con tetón M10x10 en la cazoleta(48 y 52mm)
M10x10 Dowel on hinge cup
- Tetón M8x10 en la cazoleta(45mm)
M8x10 Dowel on hinge cup for 313 45 01
- Material: Hierro con baño de Níquel
Material: Iron with nickel plating
- Sistema de montaje de la base: CLIP
Plate fixed with clip system

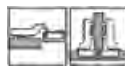

313 48 02/ 313 52 02

Acodada Half overlay



313 48 03/ 313 52 03

Súper acodada Inset



Incluidos
Included

313 48 E

AC



SERIE	CÓDIGO	📦
313	48 01E	100
	48 02E	100
	48 03E	100

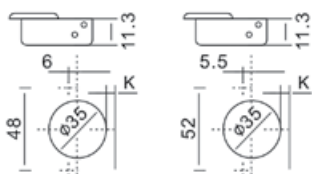

- **Cierre suave**
Soft closing type
- **Ángulo de apertura 105°**
Opening angle: 105°
- **Profundidad de la cazoleta: 11.3mm**
Depth of hinge cup: 11.3mm
- **Diámetro de la cazoleta: 35mm**
Diameter of hinge cup: 35mm
- **Bisagra con ajustes 3D con excéntrica**
3D adjustments
- **Distancia entre tornillos en la cazoleta: 48mm**
Hole distance on hinge cup: 48mm
- **Material: Hierro con baño de Níquel**
Material: Iron with nickel plating
- **Incluye tornillo Euro en la base**
With Euro screw on hinge plate
- **Sistema de montaje de la base: CLIP**
Plate fixed with clip system
- **Tetón M10x10 en la cazoleta**
M10x10 dowel on hinge cup



313 48 01E
Recta *Full overlay*



313 48 02E
Acodada *Half overlay*

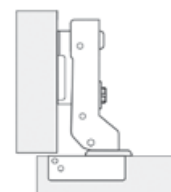

313 48 03E
Súper acodada *Inset*

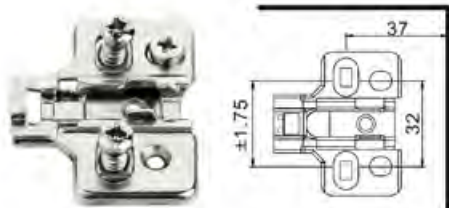

Incluyen base
Included

316 35



316 35 01

Recta *Full overlay*

SERIE	CÓDIGO	
316	35 01	100
	35 02	100
	35 03	100

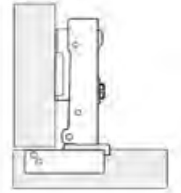
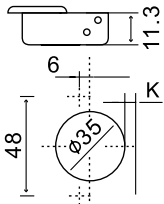

- Ángulo de apertura 105°
Opening angle: 105°
- Profundidad de la cazoleta: 11.3mm
Depth of hinge cup: 11.3mm
- Diámetro de la cazoleta: 35mm
Diameter of hinge cup: 35mm
- Bisagra con ajustes 3D con excéntrica
3D adjustments
- Distancia entre tornillos en la cazoleta: 48mm
Hole distance on hinge cup: 48mm
- Material: Hierro con baño de Níquel
Material: Iron with nickel plating
- Sistema de montaje de la base: CLIP
Plate fixed with clip system



316 35 02

Acodada *Half overlay*



316 35 03

Súper acodada *Inset*



316 35



SERIE	CÓDIGO	
316	35 1	100
	35 2	100
	35 3	100

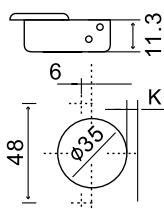

- Ángulo de apertura 105°
Opening angle: 105°
- Profundidad de la cazoleta: 11.3mm
Depth of hinge cup: 11.3mm
- Diámetro de la cazoleta: 35mm
Diameter of hinge cup: 35mm
- Bisagra con ajustes 3D con excéntrica
3D adjustments
- Distancia entre tornillos en la cazoleta: 48mm
Hole distance on hinge cup: 48mm
- Material: Hierro con baño de Níquel
Material: Iron with nickel plating
- Sistema de montaje de la base: CLIP
Plate fixed with clip system



316 35 1
Recta *Full overlay*



316 35 2
Acodada *Half overlay*



316 35 3
Súper acodada *Inset*



Accesorios *Accessories*



Ref. 316 CC



Ref. 316 CB

316...

AC

SERIE	CÓDIGO	
316	45 01	48 01
		48 02
		48 03
	52 01	52 02
		52 03

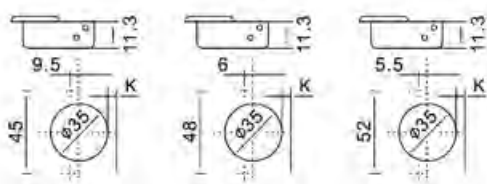

- Ángulo de apertura 105°
Opening angle: 105°
- Profundidad de la cazoleta: 11.3mm
Depth of hinge cup: 11.3mm
- Diámetro de la cazoleta: 35mm
Diameter of hinge cup: 35mm
- Bisagra con ajustes 3D con excéntrica
3D adjustments
- Distancia entre tornillos en la cazoleta:
45mm, 48mm, 52mm
*Hole to hole distance on hinge cup:
45mm, 48mm, 52mm*
- Con tetón M10x10 en la cazoleta(48mm y 52mm)
M10x10 dowel on hinge cup
- Con tetón M8x10 en la cazoleta(316 45 01)
M8x10 dowel on hinge cup(316 45 01)
- Material: Hierro con baño de Níquel
Material: Iron with nickel plating
- Sistema de montaje de la base: CLIP
Plate fixed with clip system



Incluidos
Included



316 45 01/316 48 01/ 316 52 01

Recta *Full overlay*

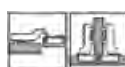
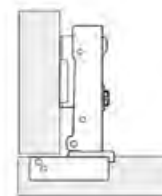

316 48 02/ 316 52 02

Acodada *Half overlay*

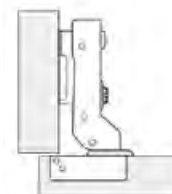

316 48 03/ 316 52 03

Súper acodada *Inset*



- Bases ajustables para bisagras 313 y 316
Adjustable bases for 313 and 316 hinges

316 H AC

SERIE	CÓDIGO		
316	H0	Altura <i>Heigh</i> h=0	500
	H2	Altura <i>Heigh</i> h=2	500

316 H0/ 316 H2

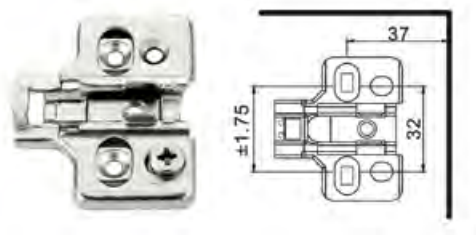

316 35BT AC

SERIE	CÓDIGO		
316	35BTH0	Altura <i>Heigh</i> h=0	500
	35BT	Altura <i>Heigh</i> h=2	500

Taco M5 en la base
M5 dowel on plate

31635BTH0/ 31635BT

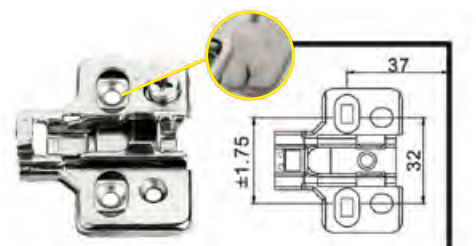

- Cubre cazoleta para bisagras 313 y 316
Cup cover for 313 and 316 hinges

316 CC 100 AC



- Cubre brazo de bisagra para bisagras 313 y 316
Arm cover for 313 and 316 hinges

316 CB 100 AC





SISTEMA
DE CAJONES

HERRAJES PARA MUEBLES





CAJÓN CIERRE SUAVE
SOFT CLOSING DRAWER

220-08 **G** Gris Grey

221-08 **B** Blanco White



220/221-08  
.....1.....6

MODELOS	REFERENCIA	TAMAÑO	PROFUNDIDAD MÍNIMA DEL MÓDULO	ALTURA <small>mm</small>
220	08 30	300	320	83
221	08 35	350	370	
G	08 40	400	420	
B	08 45	450	470	
	08 50	500	520	
	08 55	550	570	

• JUEGO DE GUÍAS
Drawer slides



• LATERALES METÁLICOS
Side panel



• CONECTORES TRASEROS
Rear connector

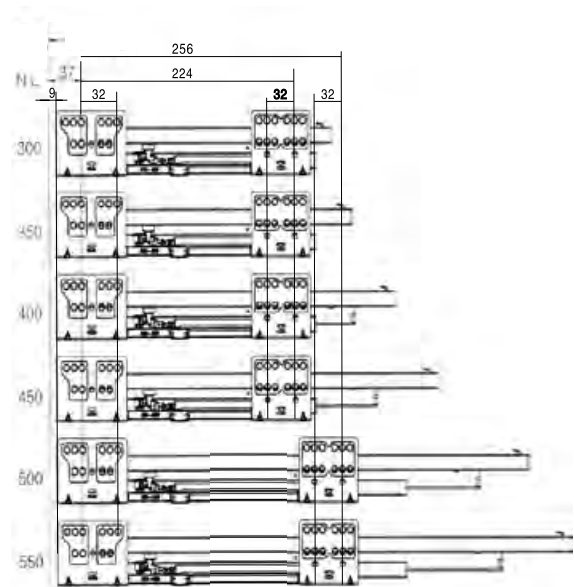

También disponible en Acero Inoxidable AISI 304. Modelo 224

Also available in INOX AISI 304(on request)



CERCO CUADRADO SIMPLE
SINGLE SQUARED BAR



220-15 **G** Gris Grey

221-15 **B** Blanco White





CERCO CUADRADO SIMPLE
SINGLE SQUARED BAR

220/221-15  10

MODELOS	REFERENCIA	TAMAÑO	PROFUNDIDAD MÍNIMA DEL MÓDULO	ALTURA <small>mm</small>
220 221  	15 30	300	320	140
	15 35	350	370	
	15 40	400	420	
	15 45	450	470	
	15 50	500	520	
	15 55	550	570	

• También disponible con cercos redondos/ Round single bar available

220 221  	14 30	300	320	140
	14 35	350	370	
	14 40	400	420	
	14 45	450	470	
	14 50	500	520	
	14 55	550	570	

COMPOSICIÓN
ORDERING INFORMATION

CAJÓN 220/221 - 08

SOFT CLOSING DRAWER SLIDE 220/221 - 08

- JUEGO DE GUÍAS
Drawer slides



- LATERALES METÁLICOS
Side panel



CERCO CUADRADO SIMPLE 220/221 - 15

SINGLE SQUARED BAR 220/221 - 15

- CONECTORES TRASEROS
Rear connector



- CERCO SIMPLE
Single bar





CERCO LATERAL DOBLE
DRAWER SLIDE WITH DOUBLE BAR



220-21 **G** Gris Grey



221-21 **B** Blanco White





CERCO CUADRADO DOBLE
DOUBLE SQUARED BAR

220/221-21  10

MODELOS	REFERENCIA	TAMAÑO	PROFUNDIDAD MÍNIMA DEL MÓDULO	ALTURA <small>mm</small>
220 221  	21 30	300	320	203
	21 35	350	370	
	21 40	400	420	
	21 45	450	470	
	21 50	500	520	
	21 55	550	570	

220 221  	30 09	Conector para cerco divisor
	30 10	Conector divisor

• También disponible con cercos redondos/ Round single bar available

220 221  	20 30	300	320	203
	20 35	350	370	
	20 40	400	420	
	20 45	450	470	
	20 50	500	520	
	20 55	550	570	

COMPOSICIÓN

ORDERING INFORMATION

CAJÓN 220/221 - 08/ SOFT CLOSING DRAWER SLIDE 220/221 - 08

- JUEGO DE GUÍAS
Drawer slides



- LATERALES METÁLICOS
Side panel



CERCO CUADRADO DOBLE 220/221 - 21/ DOUBLE SQUARED BAR 220/221 - 21

- CERCO LATERAL BLANCO 220-21
Double bar and connector



- CONECTORES TRASEROS
Rear connector



SEPARADOR INTERIOR/ INNER ORGANIZER

- CONECTOR DIVISOR
Divider 221-30 10



- CERCO DIVISOR BLANCO 221-31 02
Square bar 221-31 02



- CONECTOR PARA CERCO DIVISOR
Divider 221-30 09





CAJÓN OCULTO
INNER DRAWER

CAJÓN CIERRE SUAVE
SOFT CLOSING DRAWER

PANEL FRONTAL
FRONT PANEL

220-31

G Gris Grey

221-31

B Blanco White



CAJÓN OCULTO
INNER DRAWER

220/221-31  10

MODELOS	REFERENCIA	DESCRIPCIÓN
220 221	31 06	Panel frontal para cajón oculto
G B	31 07	Conector frontal para cajón oculto

COMPOSICIÓN
ORDERING INFORMATION

CAJÓN 220/221 - 08
SOFT CLOSING DRAWER SLIDE 220/221 - 08

• **JUEGO DE GUÍAS**
Drawer slides



• **LATERALES METÁLICOS**
Side panel



• **CONECTOR TRASERO**
Rear connector



COMPLEMENTOS CAJÓN OCULTO
INNER DRAWER ACCESSORIES

• **PANEL FRONTAL CAJÓN OCULTO**
Front panel for inner drawer

Ref. 221-31 06

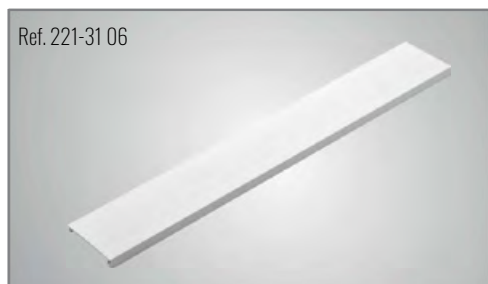

• **CONECTOR FRONTAL CAJÓN OCULTO**
Low front connector for inner drawer

Ref. 221-31 07





CAJÓN OCULTO ALTO
HIGH INNER DRAWER

CAJÓN CIERRE SUAVE
SOFT CLOSING DRAWER

PANEL FRONTAL
FRONT PANEL

220-30 **G** Gris Grey

221-30 **B** Blanco White



CAJÓN OCULTO
INNER DRAWER

220/221-30  10

MODELOS REFERENCIA DESCRIPCIÓN

MODELOS	REFERENCIA	DESCRIPCIÓN
220 221	21 30	Cerco lateral 300
G B	21 35	Cerco lateral 350
	21 40	Cerco lateral 400
	21 45	Cerco lateral 450
	21 50	Cerco lateral 500
	21 55	Cerco lateral 550
	31 06	Panel frontal 1 metro
	31 02	Cerco frontal 1 metro
	31 08	Conector frontal alto

* También disponible con cercos redondos

COMPOSICIÓN

ORDERING INFORMATION

CAJÓN 220/221 - 08

SOFT CLOSING DRAWER SLIDE 220/221 - 08

• **JUEGO DE GUÍAS**

Drawer slides



• **LATERALES METÁLICOS**

Side panel



• **CONECTOR TRASERO**

Rear connector



COMPLEMENTOS CAJÓN OCULTO

INNER DRAWER ACCESSORIES

• **PANEL FRONTAL CAJÓN OCULTO**

Front panel for inner drawer

Ref. 221-31 06



• **CERCO DIVISOR BLANCO 221-31 02**

Square bar 221-31 02



• **CONECTOR FRONTAL CAJÓN OCULTO**

High front connector for inner drawer

Ref. 221-31 08





CAJÓN LATERAL DE CRISTAL
SIDE GLASS PANEL

CAJÓN CIERRE SUAVE
SOFT CLOSING DRAWER

PANEL DE CRISTAL
GLASS PANEL



220-41 **G** Gris Grey

221-41 **B** Blanco White



PANEL LATERAL DE CRISTAL
GLASS SIDE PANEL

220/221-41  10

MODELOS	REFERENCIA	DESCRIPCIÓN
220 	41 50	Panel de cristal Glass side panel
220 221  	41 21	Accesorio montaje panel de cristal Accessories to assembly glass side panel

COMPOSICIÓN
ORDERING INFORMATION

CAJÓN 220/221 - 08
SOFT CLOSING DRAWER SLIDE 220/221 - 08

- **JUEGO DE GUÍAS**
Drawer slides



- **LATERALES METÁLICOS**
Side panel



ACCESORIOS PARA PANEL DE CRISTAL
GLASS SIDE PANEL ACCESSORIES

- **PANEL LATERAL DE CRISTAL**
Glass side panel

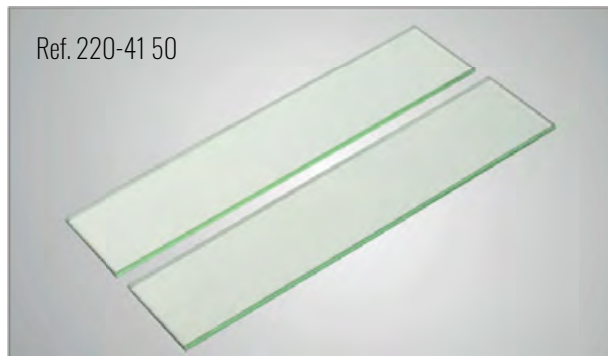

- **ACCESORIOS DE MONTAJE PANEL LATERAL**
Accessories to assembly glass side panel



- **CONECTOR TRASERO**
Rear connector



CAJÓN LIGHTBOX ALTURA 68MM
LIGHTBOX 68MM HEIGHT

225 226



Gris Antracita
Dark Grey



Blanco
White

.....1.....6

- Cajón con cierre suave y regulaciones 3D.
Diseño minimalista con panel lateral Fino.
Altura mínima de instalación 120 mm.
Acabados disponibles: Gris Antracita y Blanco.

*Soft closing drawer with 3D adjustments.
Simple design with slim side panel.
Space requirements. Height 120 mm.
Finishes available: Dark Grey and White.*



• Cotas de montaje para las guías

Installation dimension Drawer Runners

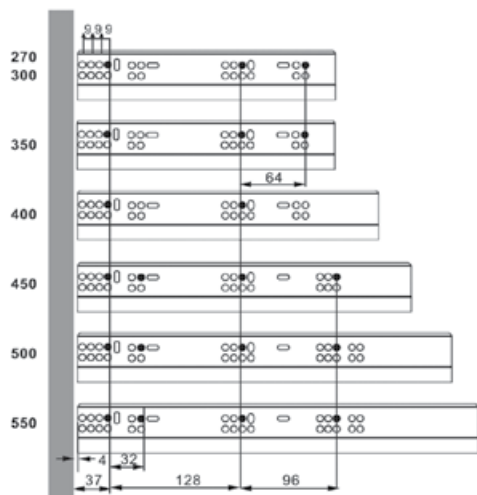

• Medidas de montaje

Back and bottom board dimensions

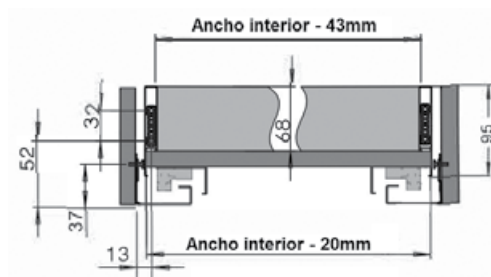

• Medidas de corte

Back and bottom board dimensions

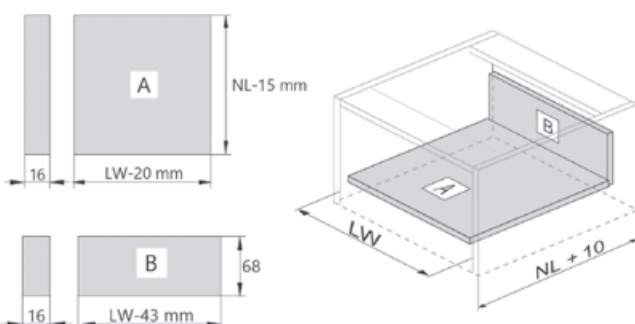

LONGITUD

GA

B

300	225 95 30	226 95 30
350	225 95 35	226 95 35
400	225 95 40	226 95 40
450	225 95 45	226 95 45
500	225 95 50	226 95 50
550	225 95 55	226 95 55

CAJÓN INTERIOR LIGHTBOX ALTURA 68MM
INNER DRAWER 68MM HEIGHT

225 226



GA Gris Antracita
Dark Grey

B Blanco
White

.....1.....6

- Cajón interior con cierre suave y regulaciones 3D. Diseño minimalista con panel lateral Fino. Altura mínima de instalación 120 mm. Acabados disponibles: Gris Antracita y Blanco.

*Inner drawer with 3D adjustments.
Simple design with slim side panel.
Space requirements. Height 120 mm.
Finishes available: Dark Grey and White.*



• **Medidas de montaje**

Back and bottom board dimensions

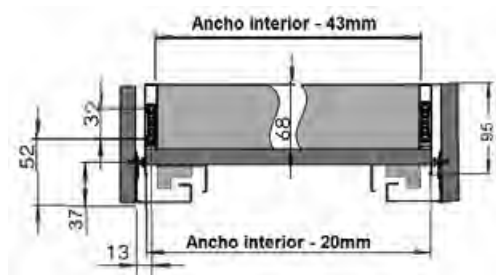

LONGITUD

GA

B

300	225 95 30	226 95 30
350	225 95 35	226 95 35
400	225 95 40	226 95 40
450	225 95 45	226 95 45
500	225 95 50	226 95 50
550	225 95 55	226 95 55

• **Panel Frontal para cajón oculto**

Front panel for inner drawer



LONGITUD

GA

B

20

1000	225 31 06	226 31 06
------	-----------	-----------

Medidas de corte:

Anchura interior del módulo - 96mm

• **Conector Inferior 68mm para Cajón oculto**

Low connector



GA

B

100

225 31 07	226 31 07
-----------	-----------

CAJÓN LIGHTBOX ALTURA 100MM
LIGHTBOX 100MM HEIGHT

225 226



GA Gris Antracita
Dark Grey

B Blanco
White

.....1.....6

- Cajón con cierre suave y regulaciones 3D.
Diseño minimalista con panel lateral Fino.
Altura mínima de instalación 155 mm.
Acabados disponibles: Gris Antracita y Blanco.

*Soft closing drawer with 3D adjustments.
Simple design with slim side panel.
Space requirements. Height 155 mm.
Finishes available: Dark Grey and White.*



• Cotas de montaje para las guías

Installation dimension Drawer Runners

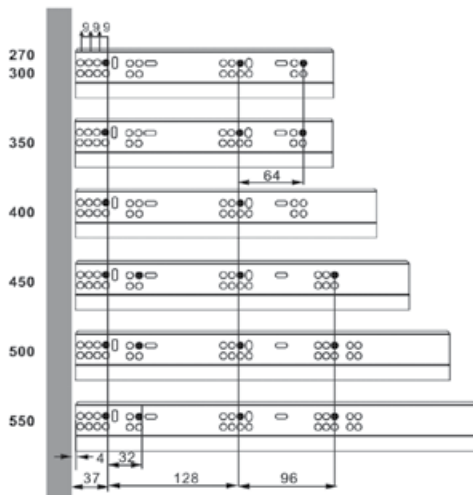

• Medidas de montaje

Back and bottom board dimensions

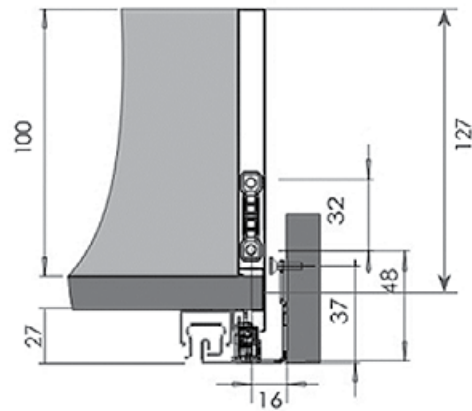

• Medidas de corte

Back and bottom board dimensions

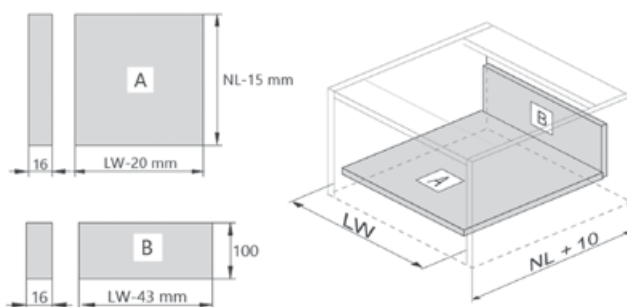

LONGITUD

GA

B

300	225 130 30	226 130 30
350	225 130 35	226 130 35
400	225 130 40	226 130 40
450	225 130 45	226 130 45
500	225 130 50	226 130 50
550	225 130 55	226 130 55

CAJÓN OCULTO LIGHTBOX ALTURA 100MM
INNER DRAWER 100MM HEIGHT

225 226



Gris Antracita
Dark Grey



Blanco
White

.....1.....6

- Cajón con cierre suave y regulaciones 3D. Diseño minimalista con panel lateral Fino. Altura mínima de instalación 155 mm. Acabados disponibles: Gris Antracita y Blanco.

*Soft closing drawer with 3D adjustments.
Simple design with slim side panel.
Space requirements. Height 155 mm.
Finishes available: Dark Grey and White.*



• Medidas de montaje

Back and bottom board dimensions

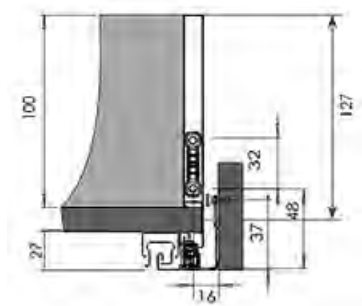

LONGITUD

GA

B

300	225 130 30	226 130 30
350	225 130 35	226 130 35
400	225 130 40	226 130 40
450	225 130 45	226 130 45
500	225 130 50	226 130 50
550	225 130 55	226 130 55

• Panel Frontal para cajón oculto

Front pannel for inner drawer



LONGITUD

GA

B

20

1000	225 31 06	226 31 06
------	-----------	-----------

Medidas de corte:

Anchura interior del módulo - 96mm

• Conector Inferior 100mm para Cajón oculto

Low connector



GA

B

100

225 32 07	226 32 07
-----------	-----------

CAJÓN LIGHTBOX ALTURA 127MM
LIGHTBOX 127MM HEIGHT

225 226



Gris Antracita
Dark Grey



Blanco
White



- Cajón interior con cierre suave y regulaciones 3D. Diseño minimalista con panel lateral Fino. Altura mínima de instalación 180 mm. Acabados disponibles: Gris Antracita y Blanco.

*Inner drawer with 3D adjustments.
Simple design with slim side panel.
Space requirements. Height 180 mm.
Finishes available: Dark Grey and White.*



• Cotas de montaje para las guías

Installation dimension Drawer Runners

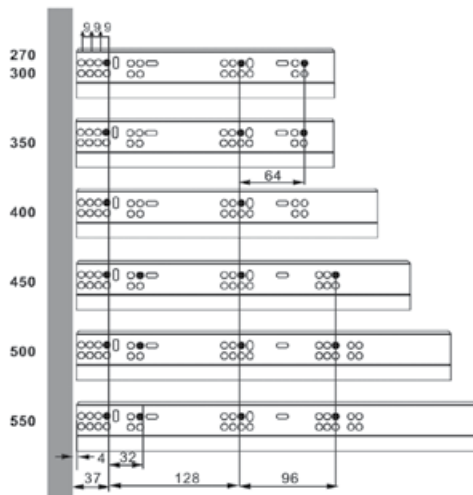

• Medidas de montaje

Back and bottom board dimensions

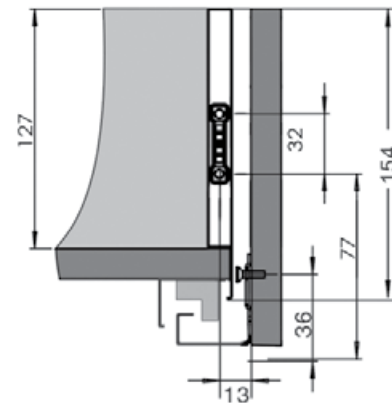

• Medidas de corte

Back and bottom board dimensions

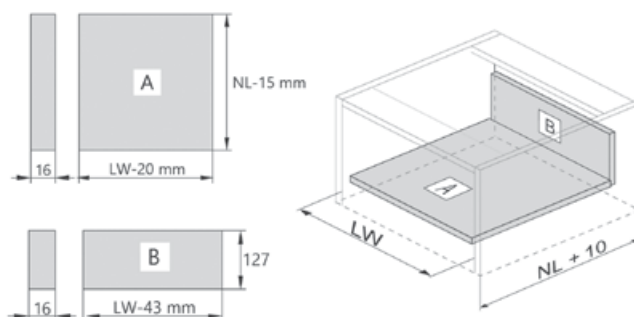

LONGITUD

GA

B

300	225 150 30	226 150 30
350	225 150 35	226 150 35
400	225 150 40	226 150 40
450	225 150 45	226 150 45
500	225 150 50	226 150 50
550	225 150 55	226 150 55

CAJÓN LIGHTBOX ALTURA 150MM
LIGHTBOX 150MM HEIGHT

225 226



GA Gris Antracita
Dark Grey

B Blanco
White

.....1.....5

- Cajón interior con cierre suave y regulaciones 3D. Diseño minimalista con panel lateral Fino. Altura mínima de instalación 203 mm. Acabados disponibles: Gris Antracita y Blanco.

*Inner drawer with 3D adjustments.
Simple design with slim side panel.
Space requirements. Height 203 mm.
Finishes available: Dark Grey and White.*



• Cotas de montaje para las guías

Installation dimension Drawer Runners

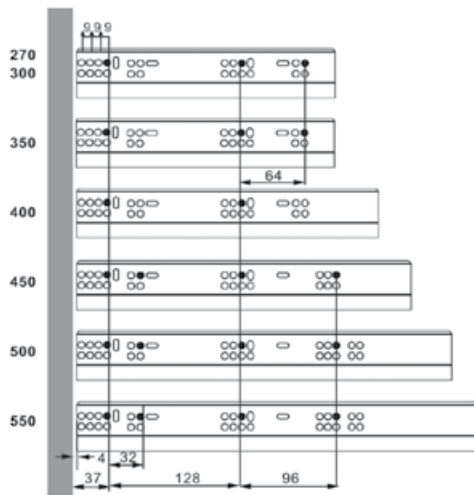

• Medidas de montaje

Back and bottom board dimensions

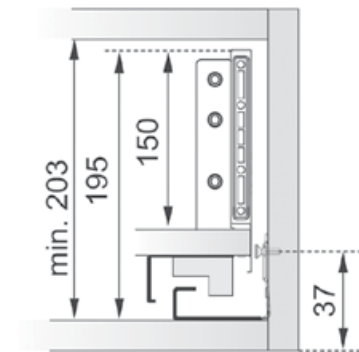

• Medidas de corte

Back and bottom board dimensions

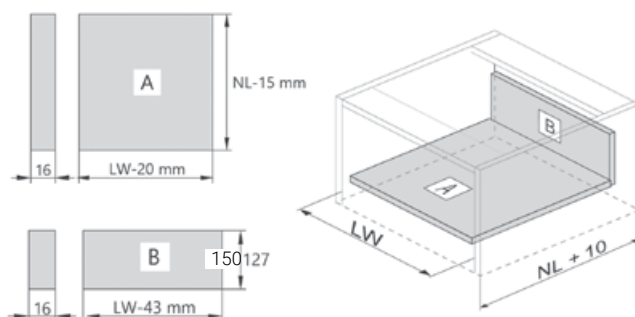

LONGITUD

GA

B

300	225 180 30	226 180 30
350	225 180 35	226 180 35
400	225 180 40	226 180 40
450	225 180 45	226 180 45
500	225 180 50	226 180 50
550	225 180 55	226 180 55

CAJÓN INTERIOR LIGHTBOX ALTURA 150MM
INNER DRAWER 150MM HEIGHT

225 226



Gris Antracita
Dark Grey



Blanco
White

.....1.....6

- Cajón interior con cierre suave y regulaciones 3D. Diseño minimalista con panel lateral Fino. Altura mínima de instalación 203 mm. Acabados disponibles: Gris Antracita y Blanco.

*Inner drawer with 3D adjuments.
Simple design with slim side panel.
Space requirements.Height 203 mm
Finishes available: Dark Grey and White.*



LONGITUD	GA	B
300	225 180 30	226 180 30
350	225 180 35	226 180 35
400	225 180 40	226 180 40
450	225 180 45	226 180 45
500	225 180 50	226 180 50
550	225 180 55	226 180 55

• Medidas de montaje

Back and bottom board dimensions

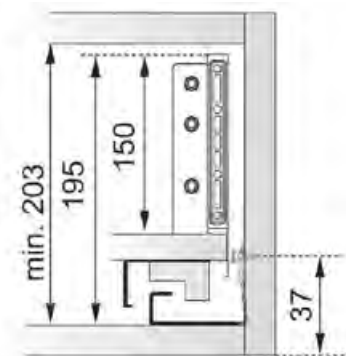

• Panel Frontal para cajón oculto

Front pannel for inner drawer



LONGITUD	GA	B
1000	225 31 06	226 31 06

20

Medidas de corte:

Anchura interior del módulo - 96mm

• Conector Inferior 150mm para Cajón oculto

Low connector



GA	B
225 33 07	226 33 07

100

• Cerco Frontal para cajón oculto alto

Front rod



GA	B
225 31 02	226 31 02

100

Medidas de corte:

Anchura interior del módulo - 73mm

CAJÓN LIGHTBOX ALTURA 180MM
LIGHTBOX 180MM HEIGHT

225 226



GA Gris Antracita
Dark Grey

B Blanco
White

.....1.....5

- Cajón con cierre suave y regulaciones 3D.
Diseño minimalista con panel lateral Fino.
Altura mínima de instalación 235 mm.
Acabados disponibles: Gris Antracita y Blanco.

*Soft closing drawer with 3D adjustments.
Simple design with slim side panel.
Space requirements. Height 235 mm
Finishes available: Dark Grey and White.*



• Cotas de montaje para las guías

Installation dimension Drawer Runners

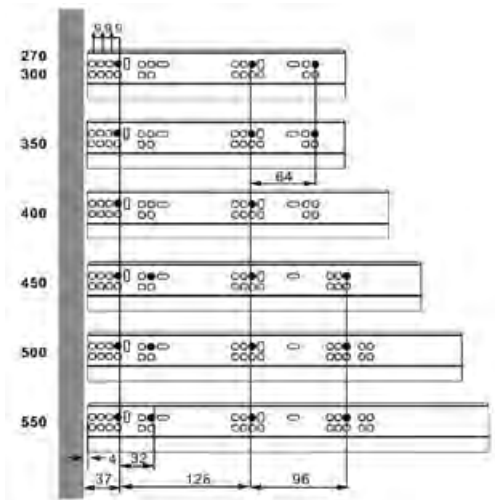

• Medidas de montaje

Back and bottom board dimensions

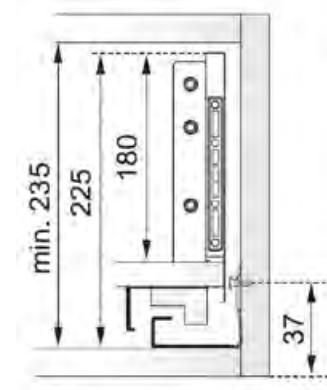

• Medidas de corte

Back and bottom board dimensions

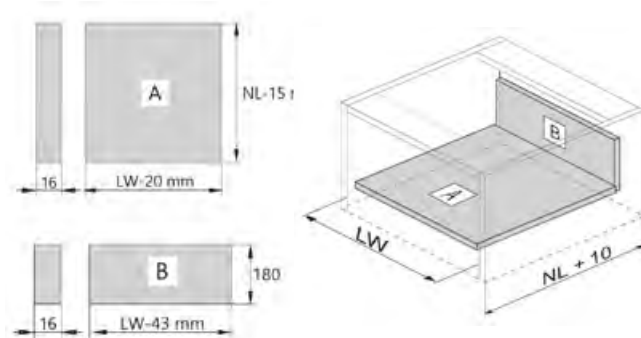

LONGITUD

GA

B

300	225 200 30	226 200 30
350	225 200 35	226 200 35
400	225 200 40	226 200 40
450	225 200 45	226 200 45
500	225 200 50	226 200 50
550	225 200 55	226 200 55

CAJÓN INTERIOR LIGHTBOX ALTURA 180MM
INNER DRAWER 180MM HEIGHT

225 226



GA Gris Antracita
Dark Grey

B Blanco
White

.....1.....6

- Cajón interior con cierre suave y regulaciones 3D. Diseño minimalista con panel lateral Fino. Altura mínima de instalación 235 mm. Acabados disponibles: Gris Antracita y Blanco.

*Inner drawer with 3D adjustments.
Simple design with slim side panel.
Space requirements. Height 235 mm
Finishes available: Dark Grey and White.*



LONGITUD	GA	B
300	225 200 30	226 200 30
350	225 200 35	226 200 35
400	225 200 40	226 200 40
450	225 200 45	226 200 45
500	225 200 50	226 200 50
550	225 200 55	226 200 55

• **Medidas de montaje**

Back and bottom board dimensions

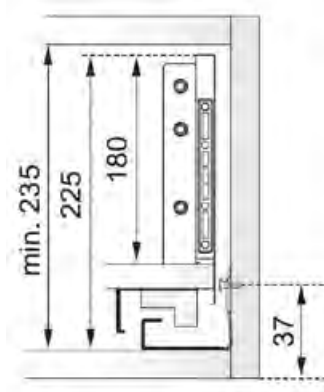

• **Panel Frontal para cajón oculto**

Front panel for inner drawer



LONGITUD	GA	B
1000	225 31 06	226 31 06

Medidas de corte:
Anchura interior del módulo - 96mm

• **Conector Inferior 180mm para Cajón oculto**

Low connector



GA	B
225 31 08	226 31 08

• **Cerco Frontal para cajón oculto alto**

Front rod



GA	B
225 31 02	226 31 02

Medidas de corte:
Anchura interior del módulo - 73mm

CERCO SIMPLE PARA CAJÓN LIGHTBOX
SIMPLE SQUARE BAR FOR LIGHTBOX

225 226

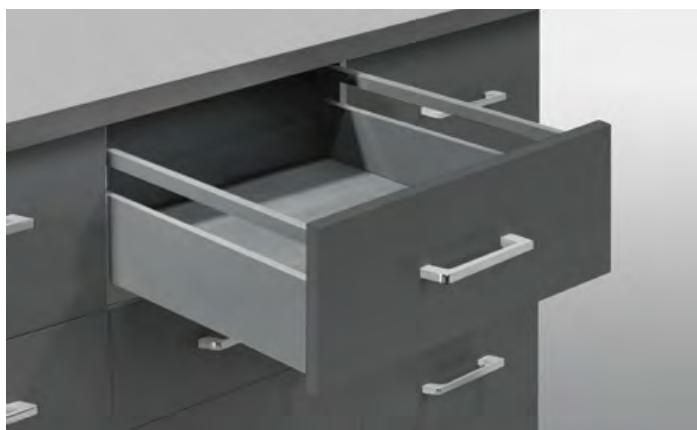

GA Gris Antracita
Dark Grey

B Blanco
White

.....10

- Puede instalarse con cualquiera de las 4 alturas de cajón disponibles.

Acabados disponibles: Gris Antracita y Blanco.

Suitable to be installed with any lightbox.

Finishes available: Dark Grey and White.



LONGITUD	GA	B
300	225 15 30	226 15 30
350	225 15 35	226 15 35
400	225 15 40	226 15 40
450	225 15 45	226 15 45
500	225 15 50	226 15 50
550	225 15 55	226 15 55

CUBERTEROS
CUTLERY TRAY



230 231



230 01 **G** Gris
Grey 10

230 02 **GA** Gris Antracita
Dark Grey 10

231 01 **B** Blanco
White 10

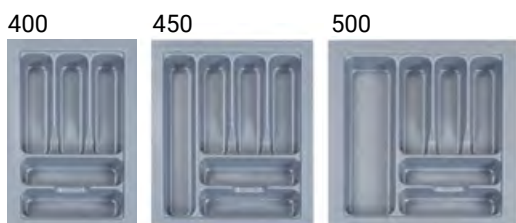

TAMAÑOS SPECIFICATION MM:

	MAX	MIN
400	330*485*60	280*435*60
450	385*485*60	335*435*60
500	430*485*60	380*435*60
600	530*485*60	480*435*60
700	630*485*60	580*435*60
800	730*485*60	680*435*60
900	830*485*60	780*435*60

h = 60 mm

SERIE	G	GA	B
230 01 400	230 02 400	231 01 400	
230 01 450	230 02 450	231 01 450	
230 01 500	230 02 500	231 01 500	
230 01 600	230 02 600	231 01 600	
230 01 700	230 02 700	231 01 700	
230 01 800	230 02 800	231 01 800	
230 01 900	230 02 900	231 01 900	

RINCONERO EXTRAIBLE
MAGIC CORNER

232 01



232-01  1

CR

SERIE	CÓDIGO	MÓDULO <small>mm</small>	MEDIDAS
232	01 80	800	591*480*604
	01 90	900	651*480*604

- Rinconero extraible acabado Cromado
Magic corner, chrome finish
- Apto para módulos de 800 y 900 mm
Suitable for 800 and 900 mm cabinets

- Tamaño mínimo puerta 400 mm para el 232 01 80
Min. Door size, 400 mm for 232 01 80
- Tamaño mínimo puerta 450 mm para el 232 01 90
Min. Door size, 450 mm for 232 01 90



RINCONERO EXTRAIBLE
MAGIC CORNER

232 03



HERRAJES PARA MUEBLES

232-03  1

CR

- Rinconero extraible acabado Cromado
Pull-out chrome basket
- Guía cuadro con cierre suave
Undermount soft closing slide
- Con apertura a derechas o izquierdas
Left and right installation for choice
- Apto para módulos de 900 mm
Cabinet width: 900 mm
- Dimensiones: 860 x 498 x 516 mm
Size: 860 x 498 x 516 mm
- Tamaño mínimo puerta: 450 mm
Minimum door size: 450 mm

SERIE	CÓDIGO	MÓDULO <small>mm</small>
232	03 90D	900
232	03 90I	900

*D Apertura a derechas (Right opening)

I Apertura a izquierdas (Left opening)



	x	w	h
232 03 90D	860	498	516
232 03 90I	860	498	516

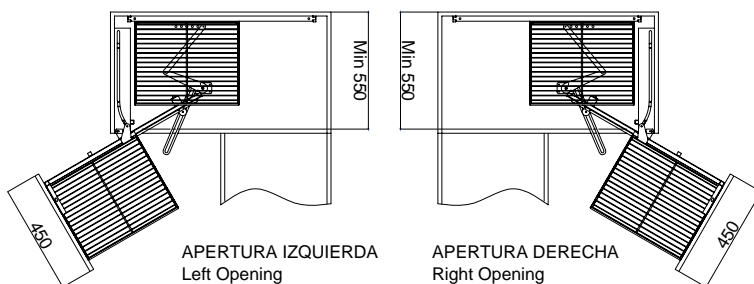

BANDEJA EXTRAIBLE CROMADA
SWING TRAY

240



240  1

CR

- **Bandeja extraible acabado Cromado**
Swing chrome tray
- **Cierre y apertura soft-closing**
Soft closing two layers
- **Capacidad de carga: 15 kg por bandeja**
Load capacity: 15 kg each layer
- **Instalación a derechas o izquierdas**
Left and right installation for choice
- **Apto para módulos de 900 mm**
Cabinet width: 900 mm
- **Dimensiones: 825 x 370 x 565 mm**
Size: 825 x 370 x 565 mm
- **Tamaño mínimo puerta: 450 mm**
Minimum door size: 450 mm

SERIE	CÓDIGO	MÓDULO <small>mm</small>
240	01 90D	900
240	01 90I	900

* **D** Apertura a derechas (Right opening)

I Apertura a izquierdas (Left opening)

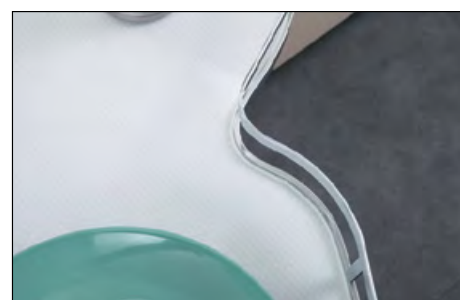

BANDEJA GIRATORIA CROMADA
270° REVOLVING BASKET

233



HERRAJES PARA MUEBLES

233  1

CR

- Disponible para módulos de 800 mm y 900 mm
Available for 800 mm or 900 mm cabinet width

SERIE	CÓDIGO	MÓDULO	ALTURA	Ø
233	01 80	800	580-850	710
233	01 90	900	580-850	810

BOTELLERO EXTRAIBLE CROMADO
PULL OUT BOTTLE BASKET

234



234  1

CR

- Apto para módulos de 150 mm y 200 mm
Can be used in 150 mm or 200 mm cabinet width
- Dispone de guía cuadro con cierre suave.
Available with concealed soft closing slides.

SERIE	CÓDIGO	MÓDULO <small>mm</small>
234	03 15	150
234	03 20	200



	x	w	h
234 03 15	470	105	550
234 03 20	470	165	550

BOTELLERO EXTRAIBLE CROMADO
PULL OUT BOTTLE BASKET

234



HERRAJES PARA MUEBLES

234  1

CR

- Apto para módulos de 300 mm y 400 mm
Can be used in 300 mm or 400 mm cabinet width
- Dispone de guía cuadro con cierre suave.
Available with concealed soft closing slides.

SERIE	CÓDIGO	MÓDULO <small>mm</small>
234	03 30	300
234	03 40	400



	x	w	h
234 03 30	455	245	535
234 03 40	455	345	535

CESTO DE LIMPIEZA CROMADO
PULL OUT BOTTLE BASKET

235



235  1

CR

- Apto para módulos de 300 mm
Cabinet width: 300 mm
- Guía con freno
With soft closing slide

SERIE	CÓDIGO	MÓDULO <small>mm</small>
235	02 30	300



	x	w	h
235 02 30	480	245	420

BOTELLERO PANERO CROMADO
BREAD BASKET

236



HERRAJES PARA MUEBLES

236  1

CR

- Apto para módulos de 300 mm a 400 mm
Available cabinet width: 300 mm - 400 mm
- Dispone de guía cuadro
Assembled with concealed soft closing slide

SERIE	CÓDIGO	MÓDULO <small>mm</small>	MEDIDAS
236	03 30	300	475*250*520
	03 40	400	475*350*520

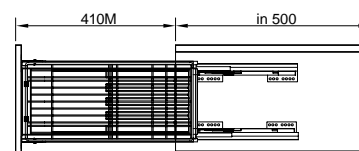

COLUMNA EXTRAIBLE CROMADA
SOFT CLOSE TALL UNIT

242



242  1

CR

- Apto para módulos de 150/200/300/400/500 mm
- Can be used in 150/200/300/400/500 mm cabinet width



SERIE	CÓDIGO	MÓDULO <small>mm</small>	x	w	h	Nº BANDEJAS
242	15 06	150	480	100	1720-2020	6
	15 06 2	150	480	100	1870-2220	6
	20 06	200	480	150	1720-2020	6
	20 06 2	200	480	150	1870-2220	6
	30 06	300	480	250	1720-2020	6
	30 06 2	300	480	250	1870-2220	6
	40 06	400	480	350	1720-2020	6
	40 06 2	400	480	350	1870-2220	6
	50 06	500	480	450	1720-2020	6
	50 06 2	500	480	450	1870-2220	6

CESTO MULTIUSOS CROMADO
PULL OUT CHROME BASKET

237



HERRAJES PARA MUEBLES

237  2

CR

- Apto para módulos de 400 mm a 900 mm
Available cabinet width: 400 mm - 900 mm
- Guía tipo cuadro
Concealed slide with soft closing
- Incluye conector para frente
Front connector included

SERIE	CÓDIGO	MÓDULO <small>mm</small>	MEDIDAS
237	03 40	400	364*425*140
	03 45	450	414*425*140
	03 50	500	464*425*140
	03 60	600	564*425*140
	03 70	700	664*425*140
	03 80	800	764*425*140
	03 90	900	864*425*140

CESTO SALVASIFÓN CROMADO
PULL OUT BASKET TO AVOID THE TRAP

241



241  1

CR

- Apto para módulos de 900 mm - 1000 mm
Available cabinet width: 900 mm - 1000 mm
- Guía tipo cuadro
Concealed slide with soft closing system

SERIE	CÓDIGO	MÓDULO <small>mm</small>	MEDIDAS
241	03 90	900	865*425*140
	03 100	1000	965*425*140



239-01  1

B

- Cubo simple 15 litros
Tilt open waste bin, 15-liter
- Apto para módulos de 300 mm
Available cabinet width: 300 mm

SERIE	CÓDIGO	MÓDULO <small>mm</small>	MEDIDAS
239	01	300	250*320*390



239-002  1

B

- Cubo doble extraíble,
de 20 litros de capacidad cada uno
*Pull out double waste bin.
Capacity: 20l each waste bin*
- Dispone de guía de extracción total
*Assembled with full extraction
ball bearing slides*

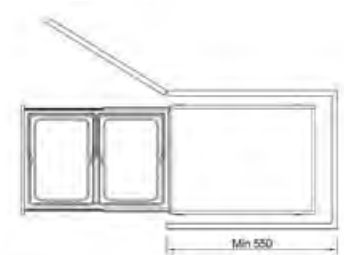

SERIE	CÓDIGO	MÓDULO <small>mm</small>	MEDIDAS
239	002 40C	400	360*490*350



239-002  1

G

- Cubo doble extraíble,
de 15 litros de capacidad cada uno
*Pull out double waste bin.
Capacity: 15l each waste bin*
- Dispone de guía cuadro con freno
*Assembled with concealed soft
closing slides*

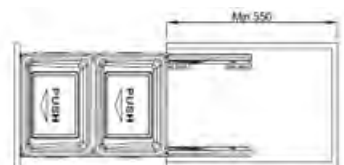

SERIE	CÓDIGO	MÓDULO <small>mm</small>	MEDIDAS
239	002 40P	400	335*480*460

ESCURREPLATOS
DISH RACKS

238

AC Acero inoxidable
Stainless steel



238  6



- Apto para módulos de 400 mm - 1000 mm
Available cabinet width: 400 mm - 1000 mm
- Fabricado en ACERO INOXIDABLE
Made of stainless steel 304

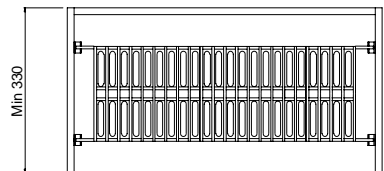

SERIE	CÓDIGO	MÓDULO (mm)	MEDIDAS
238	01 40	400	365*280*65
	01 45	450	415*280*65
	01 50	500	465*280*65
	01 60	600	565*280*65
	01 70	700	665*280*65
	01 80	800	765*280*65
	01 90	900	865*280*65
	01 100	1000	965*280*65



ELEVABLES PARA PUERTA DE COCINA



HERRAJES PARA MUEBLES

COMPÁS DE GAS ELEVABLE
GAS SPRING

320 01

320 10 100

- Longitud 252 mm c-c
Size: 252 mm c-c
- Instalación lateral
Side installation



SERIE	CÓDIGO	FUERZA(N)
320	01 05	50
	01 08	80
	01 10	100
	01 12	120

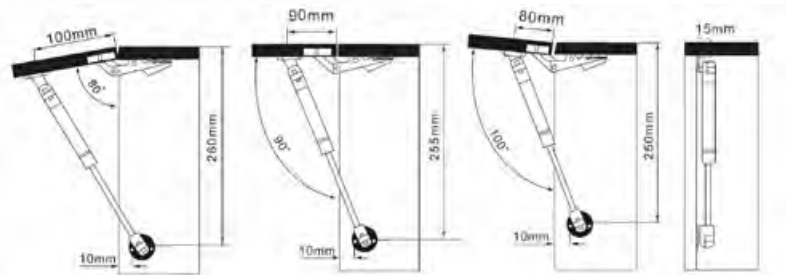

COMPÁS DE GAS ELEVABLE CORTO
GAS SPRING - SHORT VERSION

320 05

320 05 10 100

- Longitud 167 mm c-c
Size: 167 mm c-c
- Instalación lateral
Side installation



SERIE	CÓDIGO	FUERZA(N)
320	05 05	50

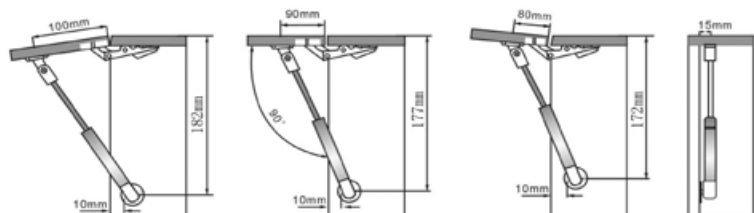

COMPÁS DE GAS ELEVABLE
GASS SPRING

320 30

320.30

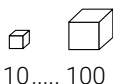

- Longitud 275 mm c-c
Size: 275 mm c-c
- Potencias: 50N, 80N, 100N, 120N, 150N
Strength: 50N, 80N, 100N, 120N, 150N
- Acabado Gris Plata
Finish: Silver grey
- Apto para montar en puertas elevables de madera y con marco de aluminio
Suitable for wood and aluminium doors
- Cierre suave con ángulo de entrada en funcionamiento del freno ajustable
Adjustable soft closing system



Entrada en funcionamiento del freno ajustable.
Se puede elegir el ángulo desde el cual se desea que el freno empiece a funcionar.

SERIE	CÓDIGO	FUERZA(N)
320	30 05	50N
	30 08	80N
	30 10	100N
	30 12	120N
	30 15	150N

COMPÁS DE GAS ABATIBLE
DOWN SUPPORT

321

321

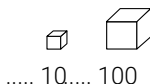

- Longitud 252 mm c-c
Size: 252 mm c-c
- Instalación lateral
Side installation
- Ángulo de apertura 105°
Opening angle: 105°
- Profundidad de la cazoleta: 11.3mm
Depth of hinge cup: 11.3mm
- Diámetro de la cazoleta: 35mm
Diameter of hinge cup: 35mm



SERIE	CÓDIGO	FUERZA(N)
321	01 10	100

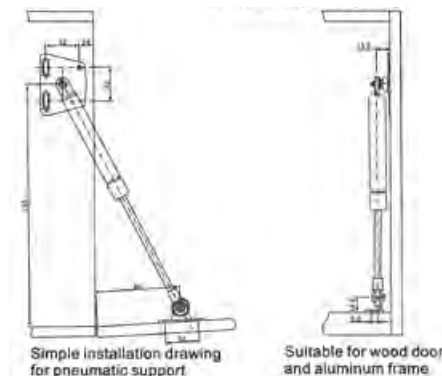

BRAZO DE SUJECIÓN
OVER TURN SUPPORT

322

322 10 100

- Tornillo para regular la fuerza
Adjusting screw
- Acabado Níquel
Finish: Nickel



SERIE	CÓDIGO
322	01 01

SOPORTE ELEVABLE
TRANSLATION PNEUMATIC TURNING
BRACKET

324

324 1 5

- Instalación lateral
Side installation
- Para muebles desde 500 a 900mm
Can be used in different cabinet width_ 500-900mm
- Altura mínima 340mm
Height: Min 340mm
- Profundidad mínima 240mm
Depth: Min 240mm



SERIE	CÓDIGO	FUERZA(N)
324	01 15	150
	01 20	200
	01 25	250
	01 30	300

SOPORTE ELEVABLE
TRANSLATION PNEUMATIC
TURNING BRACKET

325



HERRAJES PARA MUEBLES

325  20

- Acabado Níquel satinado y cromo
Finish: Satin Nickel and Chrome
- Máxima capacidad de carga: 4 kg
Load capacity: 4 kg
- Free Stop en cualquier posición por debajo de los 60° de apertura
Freestop under 60° opening
- La fuerza del elevable puede ser ajustada con el tornillo de ajuste del producto.
Adjustable strength
- Producto sin freno.
RECOMENDABLE INSTALAR CON BISAGRAS CON FRENO.
Without soft closing. Install it with soft closing hinges if soft closing is required

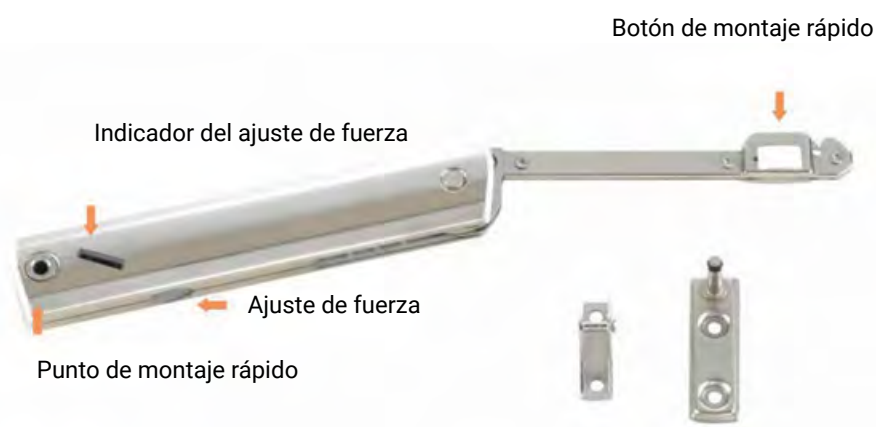

SERIE CÓDIGO

325

01 01

SOPORTE ELEVABLE
FREE STOP UPTURNING LIFT

327



• **AMPLIO ABANICO DE POSIBILIDADES**

El elevable ofrece el sistema de apertura y cierre ideal para puertas de una gran variedad de tamaños. Generalmente usadas en cocinas, salas de estar, oficinas o baños.

The item provides the ideal functionality to open and close a wide range of cabinet door sizes.

• **APARIENCIA UNICA Y ESTRUCTURA COMPACTA**

Su característico diseño hace que el mueble luzca en su máximo esplendor.

Its design, makes the cabinet even look better.

• **CIERRE SUAVE Y FREE STOP.**

• Cierre amortiguado ajustable y queda fijo en la posición que deseemos mientras abrimos el armario.

Soft closing system, and has a free stop function while it goes upwards.

Funcionamiento suave y silencioso.

Smooth and quiet system.



Apertura Suave
Smooth opening



Ángulo máximo de apertura: 110°
Max. opening angle: 110°



Cierre suave y Free Stop en la apertura
Soft to close, free stop at willing.

Ventajas del producto.

Product advantages.



La fuerza de apertura y cierre es ajustable
Force of opening or closing is adjustable



Ajustes 3D del panel
Panel can make 3D adjustments



Diseño actual
Modern design

SOPORTE ELEVABLE
FREE STOP UPTURNING LIFT

327



327 1 5

B G

- Con cierre suave por debajo de 25°
La máxima apertura es de 110°
With soft closing under angle 25°, max opening angle is 110°
- No se necesita instalar bisagras
No need hinges for cabinet
- Fácil apertura, con cierre libre (Free Stop)
Easy to open, free stop function
- La fuerza de apertura y cierre es ajustable
Force of opening or closing is adjustable
- Fácil montaje y ajuste
Easy assembly and adjustment
- Dos opciones de acabado: Blanco y Gris
Different color options for decoration cover

Características

Product information

- Acabado Níquel
Finish: nickel plating
- Peso máximo que puede elevar:
Light type: Menos de 4 Kg
Light type: < 4kg
Medium type: Entre 3.5-4.8 Kg
Medium type: 3.5-4.8kg
Strong type: Entre 4.8-6.2 Kg
Strong type: 4.8-6.2kg
- Altura de la puerta permitida: de 250 a 500 mm
Cabinet height: 250-500mm
- Anchura de la puerta permitida: Hasta 900 mm
Cabinet width: Up to 900mm
- Espesor del panel permitida: 16/19/22/26/28 mm
Panel thickness: 16/19/22/26/28mm
- Ajustes 3D para el panel: +2mm en vertical, en horizontal y profundidad.
3D adjustment for panel +/- 2mm for up and down side, front and back side left and right side

Cubres de plástico en blanco o gris

Decoration cover: White or grey



Referencias

References

SERIE	CÓDIGO	TIPO	COLOR
327	01 10	Light	Blanco
	01 20	Medium	Blanco
	01 30	Strong	Blanco
	03 10	Light	Gris
	03 20	Medium	Gris
	03 30	Strong	Gris

Componentes del producto

Item list

Elevables	Blanco / Gris	Accesorios de montaje	8 tornillos M4x39mm	4 tornillos M4x16mm

PANTALONERO EXTRAIBLE
FULL EXTRACTION TROUSER RACK

250 11

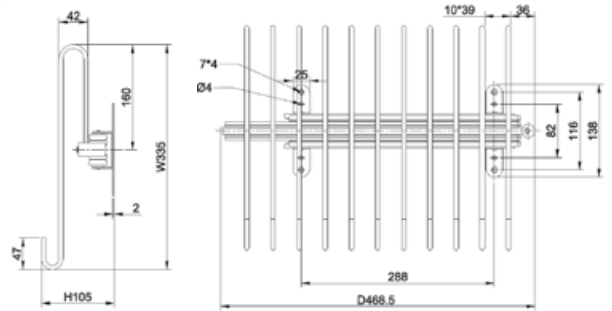

250 2 8

CR

- Apto para fondos de 500 mm
Min. cabinet depth: 500 mm
- Incluye tratamiento antideslizante (250 11 01)
Non-slip surface (250 11 01)

DESCRIPCIÓN	SERIE	CÓDIGO
Con funda antideslizante <i>Anti-slip cover</i>	250	11 01
Sin funda antideslizante <i>Without anti-slip cover</i>	250	11 02

PANTALONERO EXTRAIBLE
FULL EXTRACTION TROUSER RACK

250 18

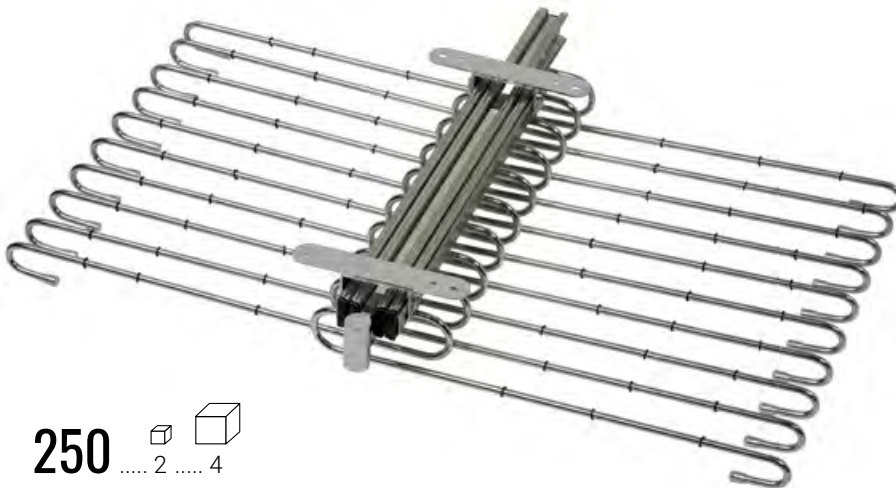

250 2 4

CR

- Apto para fondos de 500 mm
Min. cabinet depth: 500 mm
- Dimensiones/ *Size*: 680 x 465 x 105 mm

DESCRIPCIÓN	SERIE	CÓDIGO
Sin funda antideslizante <i>Without anti-slip cover</i>	250	18 02

ZAPATERO EXTRAIBLE
FULL EXTRACTION SHOE RACK

251

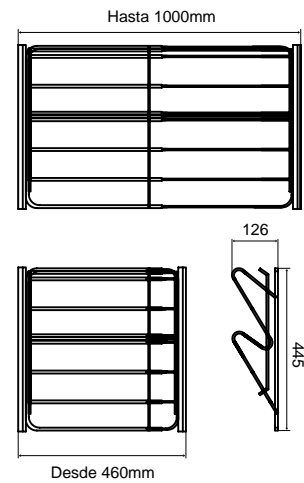

251 1 4

CR

- Apto para fondos de 500 mm
Min. cabinet depth: 500 mm
- Extensible desde 460 mm de ancho a 1000 mm
Scalable from 460mm width, up to 1000mm
- Conector frontal incluido
Front connector included

SERIE	CÓDIGO	LONGITUD <small>mm</small>
251	46 01	460-800
	56 01	560-1000

HERRAJES PARA MUEBLES

PERCHERO ABATIBLE
WARDROBE LIFTER

255



255 1 6

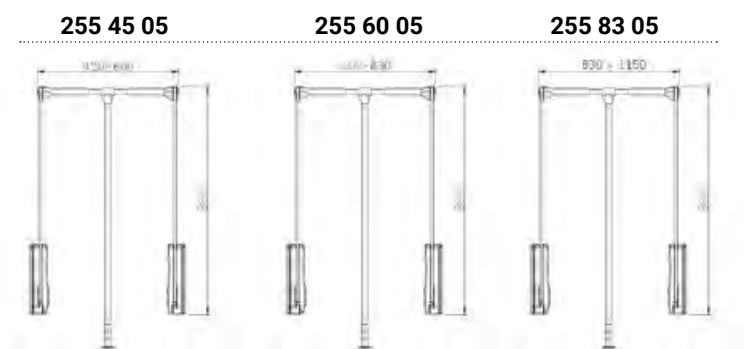

CR

- Acabado cromado
Chrome finish
- Capacidad máxima de carga 12 kg
Load capacity: 12 kg



SERIE	CÓDIGO	LONGITUD <small>mm</small>
255	45 05	450-600
	60 05	600-830
	83 05	830-1150

AL

401 25 200

AL Aluminio
Aluminium



NS 401.01.28



CR 401.04.28



PVD 401.08.28



N 401.07.28

403 25 200

AL Aluminio
Aluminium

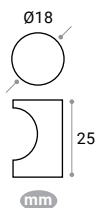

NS 403.01.18



N 403.07.18

IN

404 25 200

Acero inoxidable
Stainless Steel

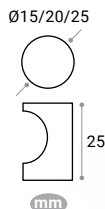

IN 404.15.01



IN 404.20.01



IN 404.25.01



POMITOS Y TIRADORES

405 25200

Z Zamak
Zamak

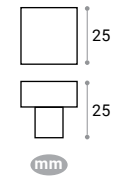

NS 405.25.01



CR 405.25.04



CRM 405.25.05



N 405.25.07



T 405.25.15T



BM 405.25.23

408 25200

Z Zamak
Zamak

70 x 40



NS 408.70.01



SAT 408.70.02



CS 408.70.06



N 408.70.07

TIRADORES

Z

420 10 100

Z Zamak
Zamak



MEDIDAS  CÓDIGO ACABADOS

	NS	N
96	420 1 096	420 7 096
128	420 1 128	420 7 128
160	420 1 160	420 7 160
192	420 1 192	420 7 192
224	420 1 224	420 7 224

AL

421 10 100

AL Aluminio
Aluminium

ALU



MEDIDAS  CÓDIGO

	CÓDIGO
96	421 1 096
128	421 1 128
160	421 1 160
192	421 1 192
224	421 1 224
256	421 1 256
288	421 1 288
320	421 1 320
384	421 1 384
480	421 1 480
576	421 1 576
672	421 1 672
840	421 1 840
1105	421 1 1105

10 50

TIRADORES

422  

Z Zamak
Zamak

Z



mm CÓDIGO ACABADOS

NS

422 1 128
422 1 160
422 1 192
422 1 224

HERRAJES PARA MUEBLES

423  

Acero inoxidable
Stainless Steel



IN

IN



MEDIDAS **mm** CÓDIGO ACABADOS

NS

N

120 x 40 423 10 01 423 10 07

TIRADORES

423  10  100

IN

Acero inoxidable
Stainless Steel



MEDIDAS  CÓDIGO ACABADOS

	NS	N
100 x 50	423 90 01	423 90 07
130 x 50	423 115 01	423 115 07



Z

425  10  100

Z Zamak
Zamak

MEDIDAS  CÓDIGO ACABADOS

	NS	CR
 128	425 1 128	425 4 128
192	425 1 192	425 4 192
256	425 1 256	425 4 256







TIRADORES

426  
.....10100



Z Zamak
Zamak

Z



MEDIDAS 	CÓDIGO			ACABADOS
				
96	426 1 096	426 4 096	426 5 096	426 7 096
128	426 1 128	426 4 128	426 5 128	426 7 128
160	426 1 160	426 4 160	426 5 160	426 7 160
192	426 1 192	426 4 192	426 5 192	426 7 192

HERRAJES PARA MUEBLES

427  
.....10100

Z Zamak
Zamak

Z



MEDIDAS 	CÓDIGO			ACABADOS
				
96	427 1 096	427 4 096	427 5 096	
160	427 1 160	427 4 160	427 5 160	

TIRADORES



IN

430 10100

IN

Acero inoxidable **MACIZO**
Solid stainless Steel

MEDIDAS  CÓDIGO ACABADOS

Ø12			
	96	430 1 096	430 7 096
	128	430 1 128	430 7 128
	160	430 1 160	430 7 160
	192	430 1 192	430 7 192
	224	430 1 224	430 7 224
	256	430 1 256	430 7 256
	288	430 1 288	430 7 288
	320	430 1 320	430 7 320
	384	430 1 384	430 7 384
	480	430 1 480	430 7 480
	576	430 1 576	430 7 576
	672	430 1 672	430 7 672
	792	430 1 792	430 7 792
	840	430 1 840	430 7 840
	1105	430 1 1105	430 7 1105

1050

IN

431 10100

IN

Acero inoxidable **HUECO**
Hollow stainless Steel

MEDIDAS  CÓDIGO ACABADOS

Ø12		
	96	431 1 096
	128	431 1 128
	160	431 1 160
	192	431 1 192
	224	431 1 224
	256	431 1 256
	288	431 1 288
	320	431 1 320
	384	431 1 384
	480	431 1 480
	576	431 1 576
	672	431 1 672
	792	431 1 792
	840	431 1 840
	1105	431 1 1105

1050

TIRADORES

432  
.....10100

IN



Acero inoxidable
Stainless Steel



IN

MEDIDAS  CÓDIGO ACABADOS

12x12		IN	IN
96		432 0 096	432 7 096
128		432 0 128	432 7 128
160		432 0 160	432 7 160
192		432 0 192	432 7 192
224		432 0 224	432 7 224
288		432 0 288	432 7 288
320		432 0 320	432 7 320
384		432 0 384	432 7 384
480		432 0 480	432 7 480
576		432 0 576	432 7 576
672		432 0 672	432 7 672
832		432 0 832	432 7 832



HERRAJES PARA MUEBLES

434  
.....10100

IN



Acero inoxidable
Stainless Steel



IN

MEDIDAS  CÓDIGO ACABADOS

	IN
160	434 1 160
192	434 1 192
224	434 1 224

262-279 **SISTEMA DE CAJÓN THINBOX**
ThinBox soft closing drawer slide



280-286 **HERRAJES FUNCIONALES
PARA COCINA**
Kitchen storage and organization



287-301 **HERRAJES PARA ARMARIOS**
Wardrobe hardware







OHMY
HOME



CAJÓN THINBOX DE ALTURA 60 MM
THINBOX 60 MM HEIGHT

227 228



GA Gris Antracita
Dark Grey

B Blanco
White

.....1.....6

- Cajón con cierre suave y regulaciones 3D
Diseño minimalista con panel lateral Fino
Altura interior útil: 60 mm
Altura mínima de instalación 110 mm
Acabados disponibles: Gris Antracita y Blanco
- Soft closing drawer with 3D adjuments
Simple design with slim side panel
Drawer inner height: 60mm
Cabinet space requirement: 110 mm
Finishes available: Dark Grey and white



- Espacio mínimo requerido para el montaje
Cabinet space requirement

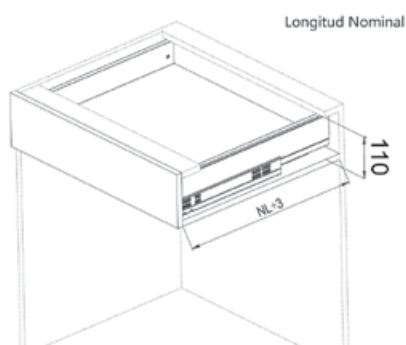

- Cotas de montaje para las guías
Installation dimension Drawer Runners

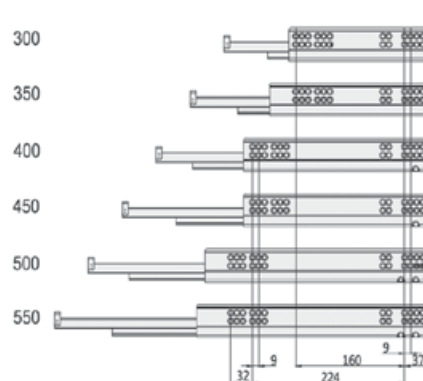

- Medidas montaje
Assembly dimensions

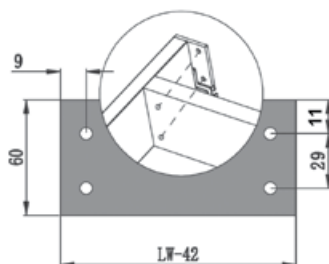
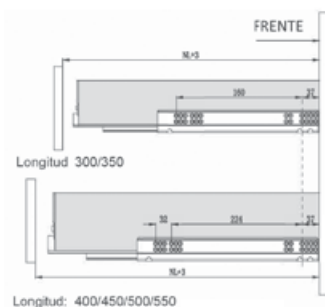

- Medidas de corte
Back and bottom board dimensions

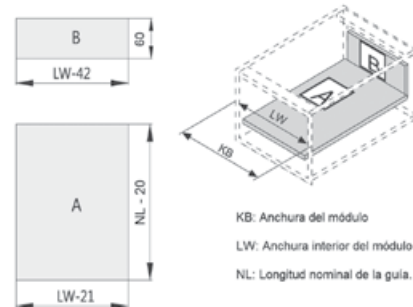

- Referencias
References

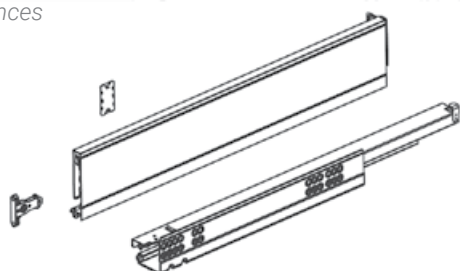

LONGITUD	GA	B
300	227 60 30	228 60 30
350	227 60 35	228 60 35
400	227 60 40	228 60 40
450	227 60 45	228 60 45
500	227 60 50	228 60 50
550	227 60 55	228 60 55



Gris Antracita
Dark Grey



Blanco
White



- Cajón con cierre suave y regulaciones 3D
Diseño minimalista CON PANEL LATERAL DE CRISTAL
Altura interior útil: 60 mm
Altura mínima de instalación 110 mm
Acabados disponibles: Gris Antracita y Blanco

*Soft closing drawer with 3D adjuments.
Simple design with slim side panel
Drawer inner height: 60 mm
Cabinet space requirement: 110 mm
Finishes available: Dark Grey and white*



- Espacio mínimo requerido para el montaje
Cabinet space requirement

- Cotas de montaje para las guías
Installation dimension Drawer Runners

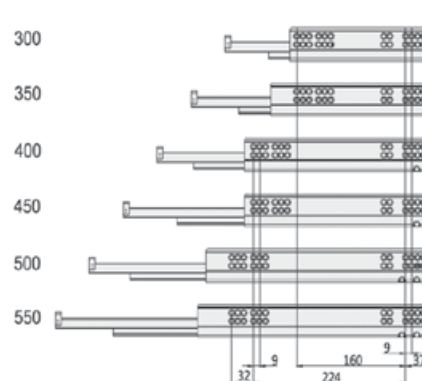
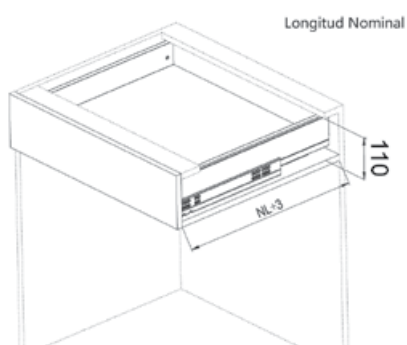

- Medidas montaje
Assembly dimensions

- Medidas de corte
Back and bottom board dimensions

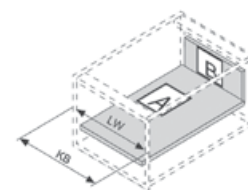
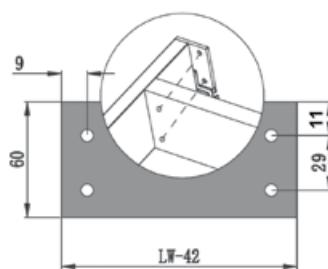
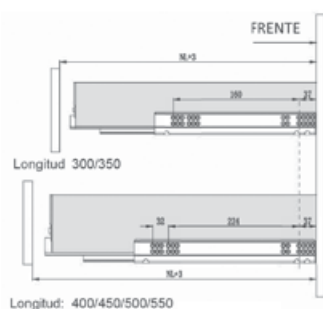

KB: Anchura del módulo
LW: Anchura interior del módulo
NL: Longitud nominal de la guía.

- Referencias
References

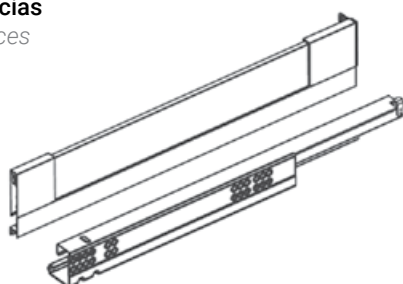

LONGITUD

GA

B

500

227 60 50C

228 60 50C

CAJÓN INTERIOR THINBOX DE ALTURA 60 MM
INNER DRAWER 60 MM HEIGHT



GA Gris Antracita
Dark Grey

B Blanco
White

- Cajón interior con cierre suave y regulaciones 3D
Diseño minimalista
Altura interior útil: 60 mm
Altura mínima de instalación 110 mm
Acabados disponibles: Gris antracita y Blanco

*Soft closing drawer with 3D adjustments
Simple design with slim side panel
Drawer inner height: 60 mm
Cabinet space requirement: 110 mm
Finishes available: Dark Grey and white*

**4 COMBINACIONES DIFERENTES PARA ADAPTAR EL CAJÓN OCULTO A LOS GUSTOS DEL CLIENTE.
4 DIFFERENT COMBINATIONS.**



Para los 4 modelos:

- Espacio mínimo requerido para el montaje
Cabinet space requirement

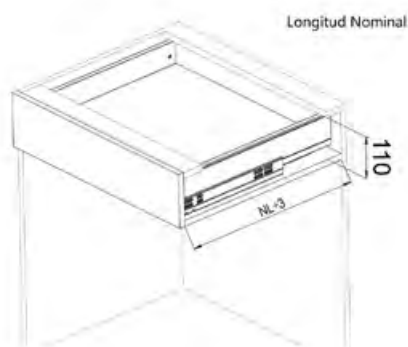

- Cotas de montaje para las guías.
Installation dimension Drawer Runners

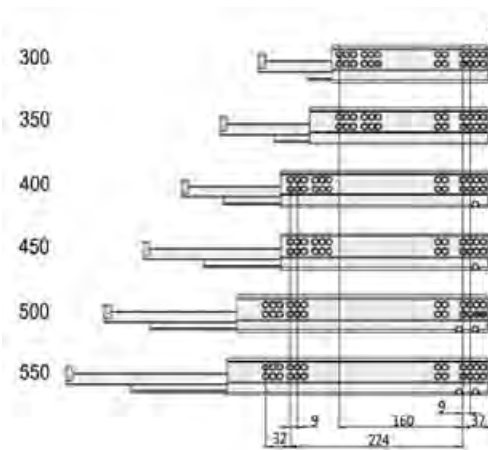

- Medidas montaje
Assembly dimensions

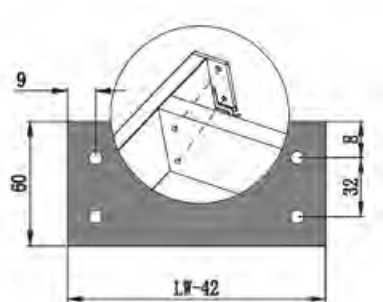

- Medidas de corte
Back and bottom board dimensions

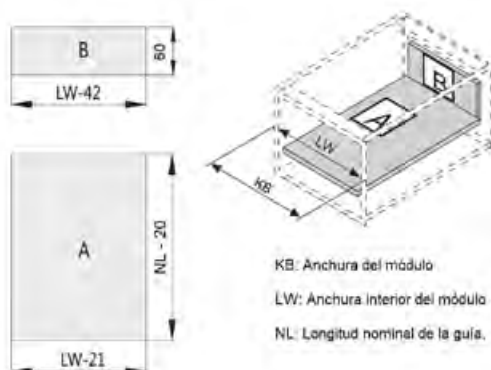

CAJÓN INTERIOR THINBOX DE ALTURA 60 MM
INNER DRAWER 60 MM HEIGHT



1 - Cajón oculto con frente y laterales metálicos
Inner drawer with front and side metal panel

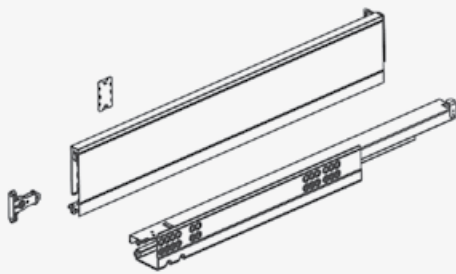

LONGITUD	GA	B	1	6
300	227 60 30	228 60 30		
350	227 60 35	228 60 35		
400	227 60 40	228 60 40		
450	227 60 45	228 60 45		
500	227 60 50	228 60 50		
550	227 60 55	228 60 55		

Panel Frontal para cajón oculto
Front pannel for inner drawer



LONGITUD	GA	B	60
1200	227 31 26	228 31 26	

Medidas de corte:
Anchura interior del módulo - 100mm
Cut dimensions: inner width - 100mm

Conector Inferior 60mm para Cajón oculto
Low connector

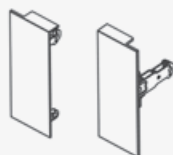

GA	B	60
227 31 27	228 31 27	

CAJÓN INTERIOR THINBOX DE ALTURA 60 MM
INNER DRAWER 60 MM HEIGHT



2 - Cajón oculto con frente de cristal
Inner drawer with glass front panel

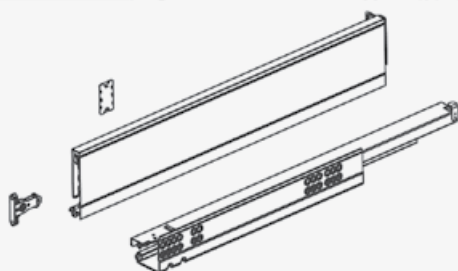
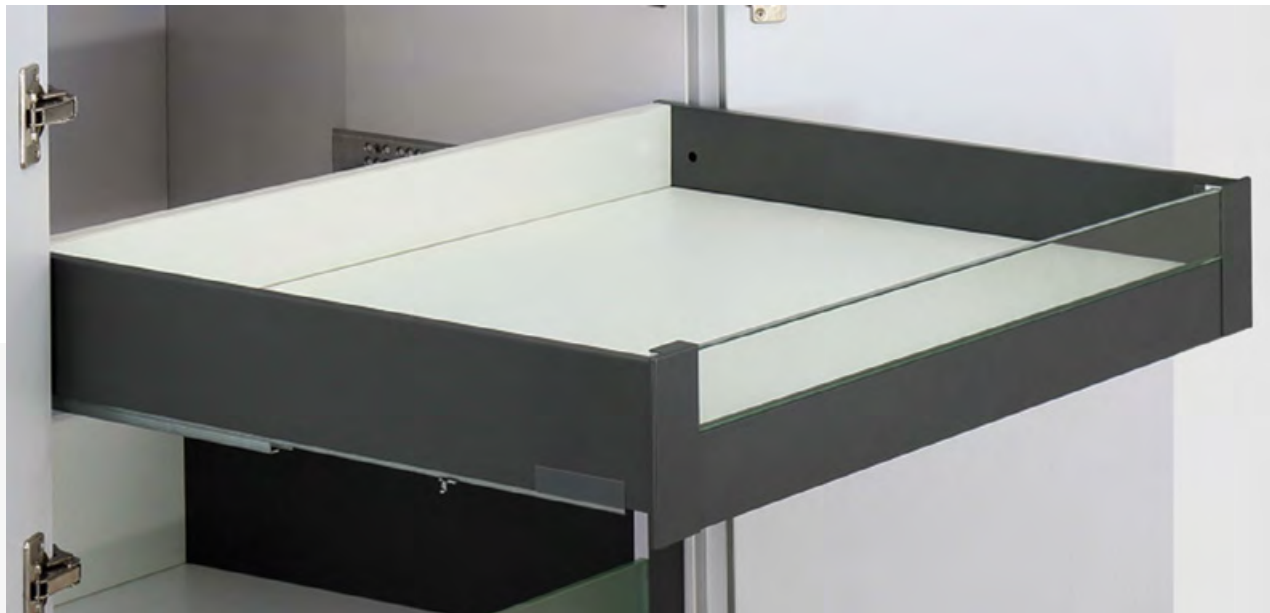

LONGITUD	GA	B	1	6
300	227 60 30	228 60 30		
350	227 60 35	228 60 35		
400	227 60 40	228 60 40		
450	227 60 45	228 60 45		
500	227 60 50	228 60 50		
550	227 60 55	228 60 55		

• **Panel Frontal para cajón oculto (Opción frente cristal)**
Front panel to be used with glass front panel

LONGITUD	GA	B	60
1200	227 41 26	228 41 26	

Medidas de corte:
Anchura interior del módulo - 100mm
Cut dimensions: inner width - 100mm

• **Frente de cristal para cajón oculto (Opción frente cristal)**
Glass front panel

LONGITUD	20
600	228 42 600

• **Conector Inferior 60mm para Cajón oculto con frente de cristal**
Low front connector with glass option

GA	B	20
227 41 27	228 41 27	

CAJÓN INTERIOR THINBOX DE ALTURA 60 MM
INNER DRAWER 60 MM HEIGHT



3 - Cajón Oculto con frente metálico y laterales de cristal
Inner drawer with glass side panel

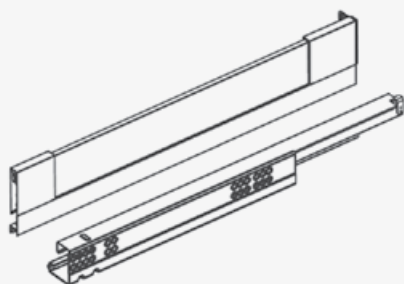

LONGITUD	GA	B	1	6
500	227 60 50C	228 60 50C		

- Panel Frontal para cajón oculto
Front panel to be used with glass front panel

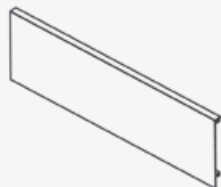

LONGITUD	GA	B	60
1200	227 31 26	228 31 26	

Medidas de corte:
Anchura interior del módulo - 100mm
Cut dimensions: inner width - 100mm

- Conector Inferior 60mm para Cajón oculto
Low front connector with glass option

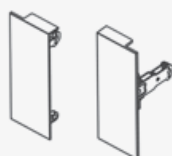

GA	B	60
227 31 27	228 31 27	

CAJÓN INTERIOR THINBOX DE ALTURA 60 MM
INNER DRAWER 60 MM HEIGHT



4 - Cajón Oculto con frente y laterales de cristal

Inner drawer with glass side/front panel

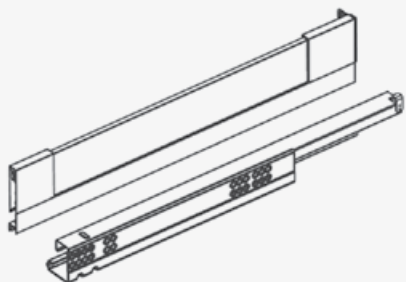

LONGITUD	GA	B	1	6
500	227 60 50C	228 60 50C		

Panel Frontal para cajón oculto (Opción frente cristal)

Front panel to be used with glass front panel



LONGITUD	GA	B	60
1200	227 41 26	228 41 26	

Medidas de corte:
Anchura interior del módulo - 100mm
Cut dimensions: inner width - 100mm

Frente de cristal para cajón oculto (Opción frente cristal)

Glass front panel



LONGITUD	20
600	228 42 600

Conector Inferior 60mm para Cajón oculto con frente de cristal

Low front connector with glass option

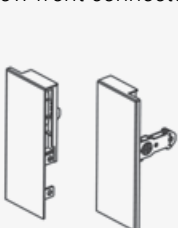

GA	B	20
227 41 27	228 41 27	



Gris Antracita
Dark Grey



Blanco
White

.....1.....6

- Cajón con cierre suave y regulaciones 3D
Diseño minimalista CON PANEL LATERAL FINO
Altura interior útil: 101 mm
Altura mínima de instalación 151 mm
Acabados disponibles: Gris Antracita y Blanco

*Soft closing drawer with 3D adjustments
Simple design with slim side panel
Drawer inner height: 101 mm
Cabinet space requirement: 151 mm
Finishes available: Dark Grey and white*



- Espacio mínimo requerido para el montaje
Cabinet space requirement

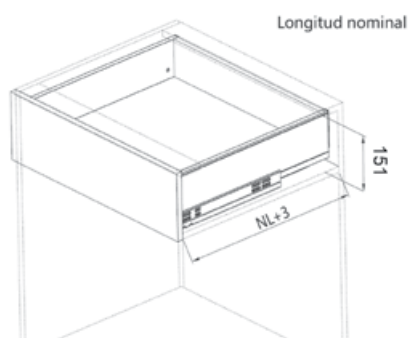

- Cotas de montaje para las guías
Installation dimension drawer runners

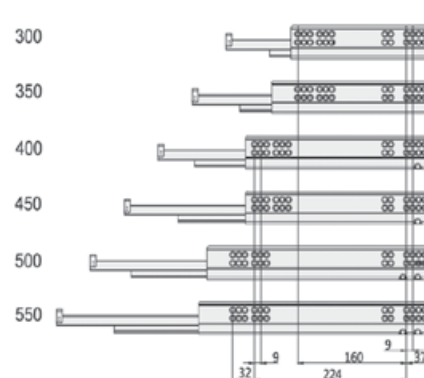

- Medidas montaje
Assembly dimensions

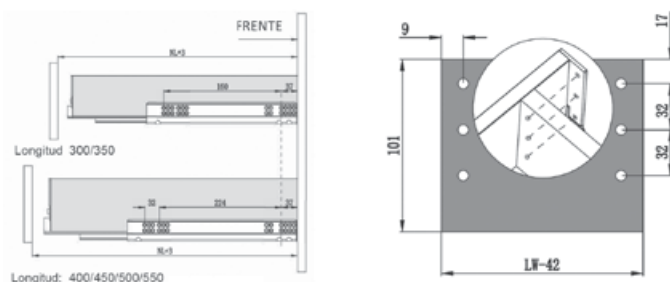

- Medidas de corte
Back and bottom board dimensions

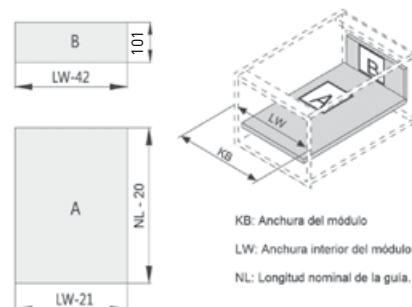

- Referencias
References

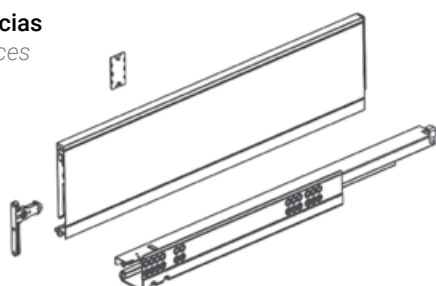

LONGITUD	GA	B
300	227 100 30	228 100 30
350	227 100 35	228 100 35
400	227 100 40	228 100 40
450	227 100 45	228 100 45
500	227 100 50	228 100 50
550	227 100 55	228 100 55



GA Gris Antracita
Dark Grey

B Blanco
White

.....1.....5

- Cajón con cierre suave y regulaciones 3D
Diseño minimalista CON PANEL LATERAL FINO
Altura interior útil: 148 mm
Altura mínima de instalación 198 mm
Acabados disponibles: Gris Antracita y Blanco

*Soft closing drawer with 3D adjustments
Simple design with slim side panel
Drawer inner height: 148 mm
Cabinet space requirement: 198 mm
Finishes available: Dark Grey and white*



- Espacio mínimo requerido para el montaje
Cabinet space requirement

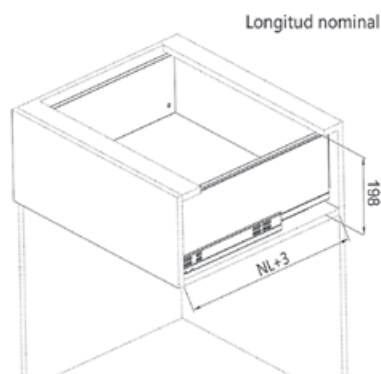

- Cotas de montaje para las guías.
Installation dimension drawer runners

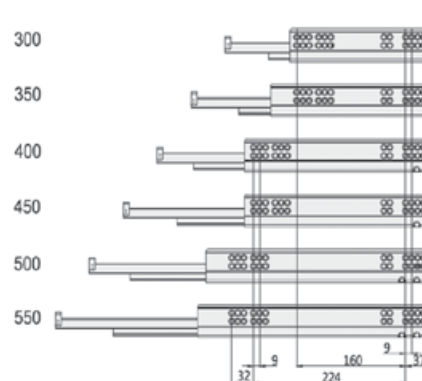

- Medidas montaje
Assembly dimensions

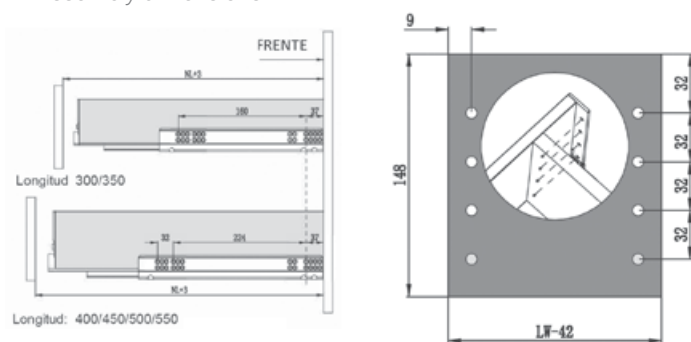

- Medidas de corte
Back and bottom board dimensions

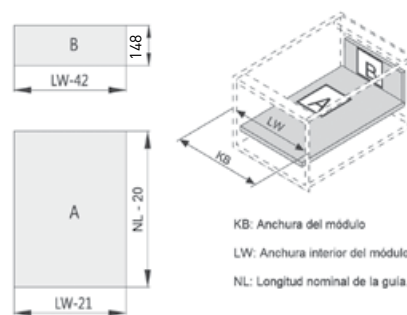

- Referencias
References

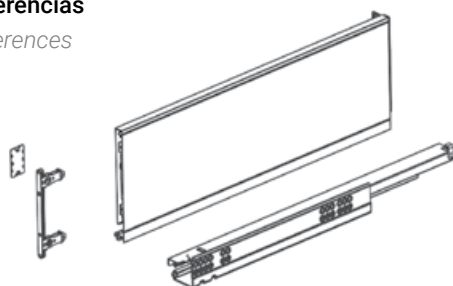

LONGITUD	GA	B
300	227 150 30	228 150 30
350	227 150 35	228 150 35
400	227 150 40	228 150 40
450	227 150 45	228 150 45
500	227 150 50	228 150 50
550	227 150 55	228 150 55



Gris Antracita
Dark Grey



Blanco
White

.....1.....5

- Cajón con cierre suave y regulaciones 3D
Diseño minimalista CON PANEL LATERAL DE CRISTAL
Altura interior útil: 148 mm
Altura mínima de instalación 198 mm
Acabados disponibles: Gris Antracita y Blanco

*Soft closing drawer with 3D adjustments
Simple design with slim side panel
Drawer inner height: 148 mm
Cabinet space requirement: 198 mm
Finishes available: Dark Grey and white*



- Espacio mínimo requerido para el montaje
Cabinet space requirement

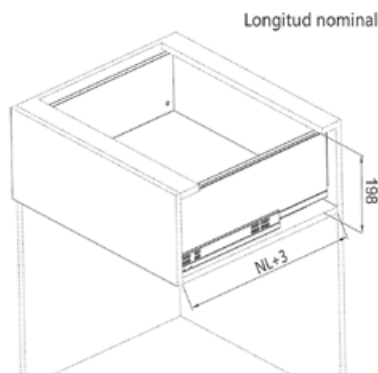

- Cotas de montaje para las guías
Installation dimension Drawer Runners

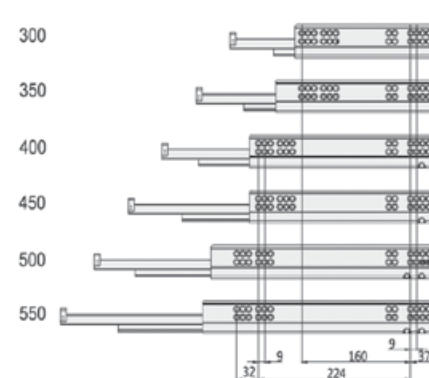

- Medidas montaje
Assembly dimensions

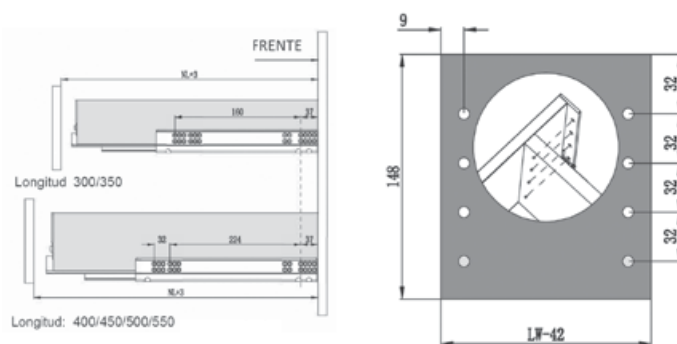

- Medidas de corte
Back and bottom board dimensions

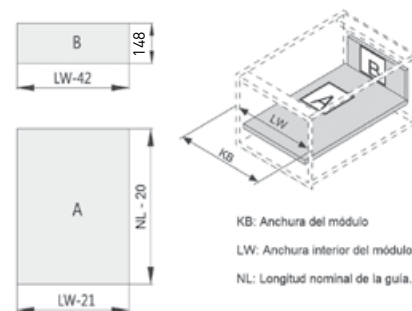

- Referencias
References

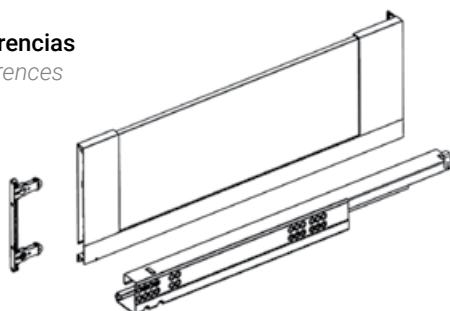

LONGITUD

GA

B

500

227 150 50C

228 150 50C

CAJÓN INTERIOR THINBOX DE ALTURA 150 MM
INNER DRAWER 150 MM HEIGHT



GA Gris Antracita
Dark Grey

B Blanco
White

- Cajón interior con cierre suave y regulaciones 3D
 Diseño minimalista
 Altura interior útil: 148 mm
 Altura mínima de instalación 198 mm
 Acabados disponibles: Gris antracita y Blanco

*Soft closing drawer with 3D adjustments
 Simple design with slim side panel
 Drawer inner height: 148 mm
 Cabinet space requirement: 198 mm
 Finishes available: Dark Grey and white*

**4 COMBINACIONES DIFERENTES PARA ADAPTAR
 EL CAJÓN OCULTO A LOS GUSTOS DEL CLIENTE.
 4 DIFFERENT COMBINATIONS.**



Para los 4 modelos:

- Espacio mínimo requerido para el montaje
Cabinet space requirement

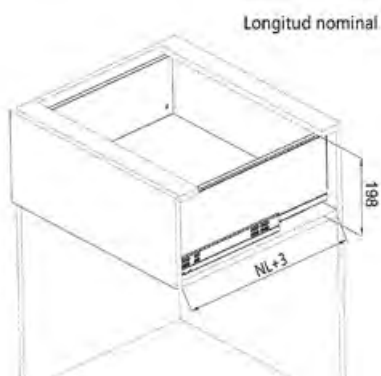

- Cotas de montaje para las guías.
Installation dimension Drawer Runners

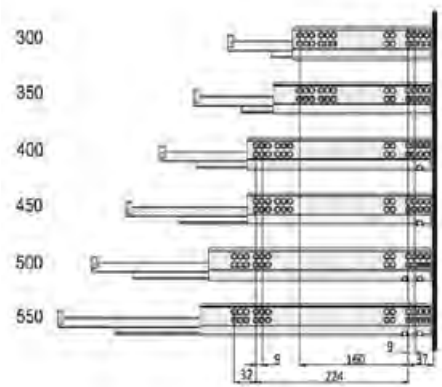

- Medidas montaje
Assembly dimensions

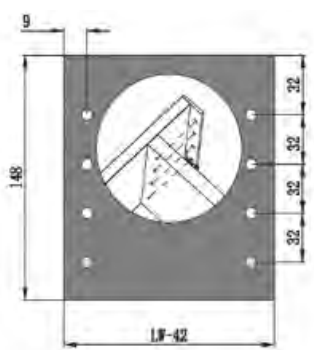

- Medidas de corte
Back and bottom board dimensions

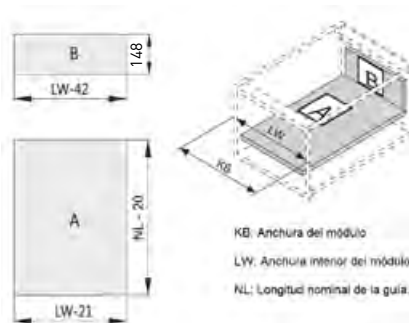

CAJÓN INTERIOR THINBOX DE ALTURA 150 MM
INNER DRAWER 150 MM HEIGHT



1 - Cajón oculto con frente y laterales metálicos
Inner drawer with front and side metal panel

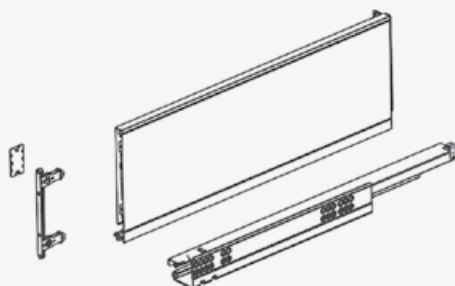

LONGITUD	GA	B	1	5
300	227 150 30	228 150 30		
350	227 150 35	228 150 35		
400	227 150 40	228 150 40		
450	227 150 45	228 150 45		
500	227 150 50	228 150 50		
550	227 150 55	228 150 55		

Panel Frontal para cajón oculto
Front panel to be used with glass front panel

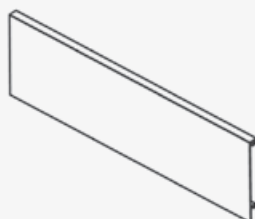

LONGITUD	GA	B	60
1200	227 31 26	228 31 26	

Medidas de corte:
Anchura interior del módulo - 100mm
Cut dimensions: inner width - 100mm

Conector Inferior 150mm para Cajón oculto
Low front connector with glass option

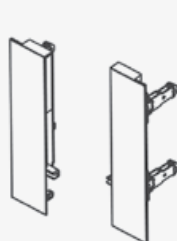

GA	B	60
227 31 29	228 31 29	

Cerco frontal para Cajón oculto
Front rod



GA	B	50
227 31 22	228 31 22	

Medidas de corte:
Anchura interior del módulo - 88mm
Cut dimensions: inner width - 88mm

CAJÓN INTERIOR THINBOX DE ALTURA 150 MM
INNER DRAWER 150 MM HEIGHT



2 - Cajón oculto con frente de cristal
Inner drawer with glass front panel

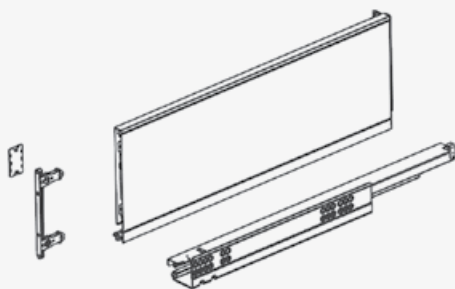

LONGITUD	GA	B	1	5
300	227 150 30	228 150 30		
350	227 150 35	228 150 35		
400	227 150 40	228 150 40		
450	227 150 45	228 150 45		
500	227 150 50	228 150 50		
550	227 150 55	228 150 55		

• **Panel Frontal para cajón oculto (Opción frente cristal)**
Front panel to be used with glass front panel

LONGITUD	GA	B	60
1200	227 41 26	228 41 26	

Medidas de corte:
Anchura interior del módulo - 100mm
Cut dimensions: inner width - 100mm

• **Frente de cristal para cajón oculto (Opción frente cristal)**
Glass front panel

LONGITUD	20
600	228 43 600

• **Conector Inferior 150mm para Cajón oculto con frente de cristal**
Low front connector with glass option

GA	B	20
227 41 29	228 41 29	

3 - Cajón Oculto con frente metálico y laterales de cristal

Inner drawer with glass side panel

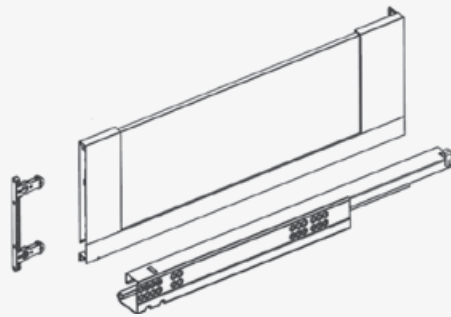

• **Panel Frontal para cajón oculto**

Front panel to be used with glass front panel

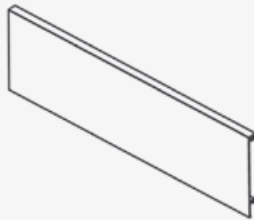

LONGITUD	GA	B	1	5
500	227 150 50C	228 150 50C		

LONGITUD	GA	B	60
1200	227 31 26	228 31 26	

Medidas de corte:
Anchura interior del módulo - 100mm
Cut dimensions: inner width - 100mm

• **Conector Inferior 150mm para Cajón oculto**

Low front connector with glass option

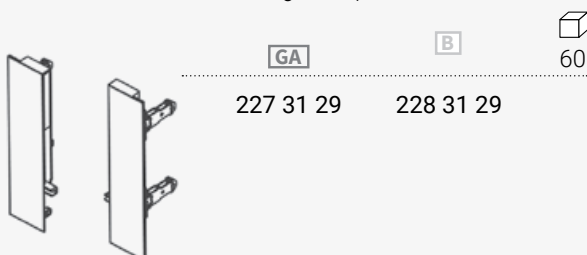

GA	B	60
227 31 29	228 31 29	

• **Cerco frontal para Cajón oculto**

Front rod

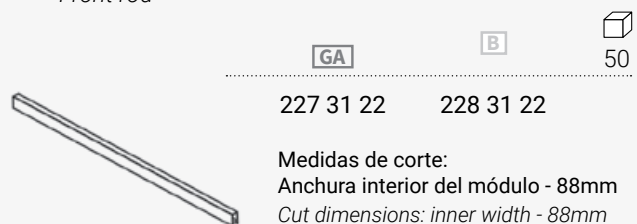

GA	B	50
227 31 22	228 31 22	

Medidas de corte:
Anchura interior del módulo - 88mm
Cut dimensions: inner width - 88mm

CAJÓN INTERIOR THINBOX DE ALTURA 150 MM
INNER DRAWER 150 MM HEIGHT



4 - Cajón Oculto con frente y laterales de cristal

Inner drawer with glass side/front panel

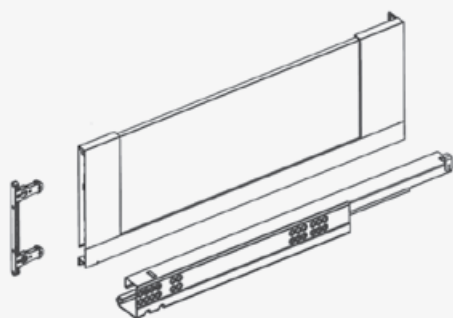

LONGITUD	GA	B	1	5
500	227 150 50C	228 150 50C		

- Panel Frontal para cajón oculto (Opción frente cristal)
Front panel to be used with glass front panel



LONGITUD	GA	B	60
1200	227 41 26	228 41 26	

Medidas de corte:
Anchura interior del módulo - 100mm
Cut dimensions: inner width - 100mm

- Frente de cristal para cajón oculto (Opción frente cristal)
Glass front panel



LONGITUD	20
600	228 43 600

- Conector Inferior 150mm para Cajón oculto con frente de cristal
Low front connector with glass option

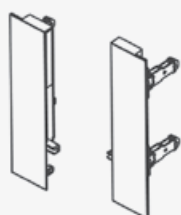

GA	B	20
227 41 29	228 41 29	

CERCO SIMPLE PARA CAJÓN THINBOX
SIMPLE SQUARE BAR FOR THINBOX

227 228



GA Gris Antracita
Dark Grey

B Blanco
White

20

- Altura de instalación a convenir
Puede instalarse en las 3 alturas de cajón disponibles.

Suitable to be installed in any thinbox.



LONGITUD	GA	B
300	227 15 30	228 15 30
350	227 15 35	228 15 35
400	227 15 40	228 15 40
450	227 15 45	228 15 45
500	227 15 50	228 15 50
550	227 15 55	228 15 55

SALVASIFÓN PARA CAJÓN THINBOX
ACCESSORY TO AVOID SIPHON

- **Accesorio salvasifón redondo**
Round design

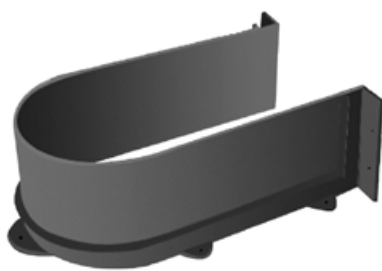

GA **B** 20
227 32 01 228 32 01



- **Accesorio salvasifón cuadrado**
Squared design



GA **B** 20
227 32 02 228 32 02



- Cubertero modular fabricado en acero inoxidable. Libre combinación para ajustarse a diferentes anchos de módulo.
Storage series made of stainless steel easy to combine.

Acero inoxidable
Stainless Steel



IN



PROFUNDIDAD DEL CAJÓN	REFERENCIA	MEDIDAS
500	230 05 01	473*104*64

PROFUNDIDAD DEL CAJÓN	REFERENCIA	MEDIDAS
500	230 05 03	473*281*64

Ancho del módulo

300mm

300/350mm

400/450/500mm

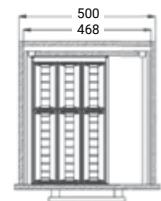
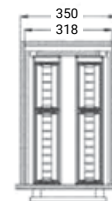

600mm

700mm

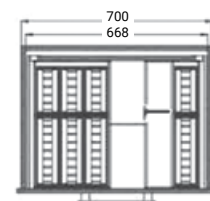
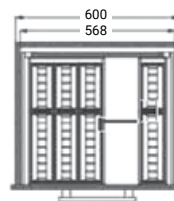

800mm

1000mm

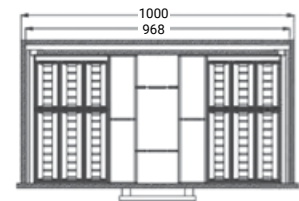
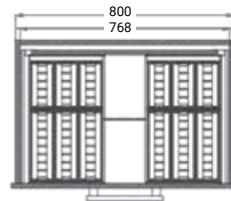

900mm

1200mm

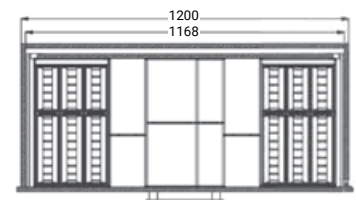
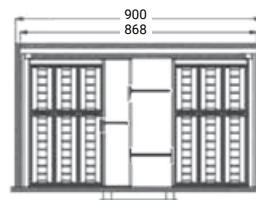

PROFUNDIDAD DEL CAJÓN	REFERENCIA	MEDIDAS
500	230 05 04	473*386*64



232 01G ¹

GA Gris Antracita
Dark Grey



SERIE	CÓDIGO	MÓDULO (mm)	x	w	h
232	01 80G	800	620	485	610

- Rinconero extraible universal
Magic corner
- Se puede instalar tanto con apertura a izquierda como a derecha
Universal installation left or right
- Acabado: Gris antracita con base de madera y goma antideslizante
Finish dark grey with wood base

- Instalación en módulo de 800mm
Suitable for 800 mm cabinet
- Tamaño mínimo puerta 400 mm
Min. Door size, 400 mm

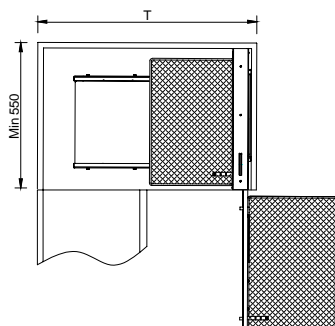



232 03G 1

GA Gris Antracita
Dark Grey

- Rinconero extraible.
Pull-out basket.
- Con apertura a derechas o izquierdas
Left and right installation for choice
- Acabado: Gris antracita con base de madera y goma antideslizante
Finish: Dark grey with wood base
- Instalación en módulo de 800mm
Suitable for 800mm cabinet
- Tamaño mínimo puerta: 450 mm
Minimum door size: 450 mm



SERIE	CÓDIGO	MÓDULO (mm)	x	w	h
232	03 80DG	800	760	500	530
232	03 80IG	800	760	500	530

* D Apertura a derechas (Right opening)

I Apertura a izquierdas (Left opening)

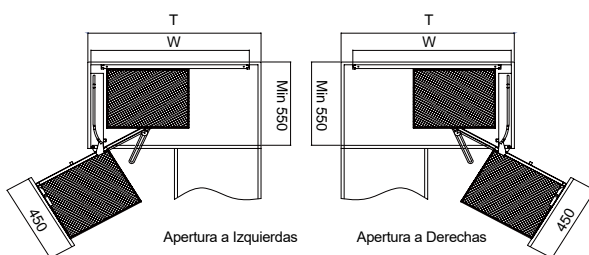

TORNO GIRATORIO 270°
270° REVOLVING BASKET

233 01G



233 01G  1

GA Gris Antracita
Dark Grey

SERIE	CÓDIGO	MÓDULO	ALTURA	Ø
233	01 80G	800	560-790	710
233	01 90G	900	560-790	800

- Torno giratorio de 270°. *270° revolving basket*
- Instalación en módulo de 800 Y 900 mm *Suitable for 800 or 900 mm cabinet size*

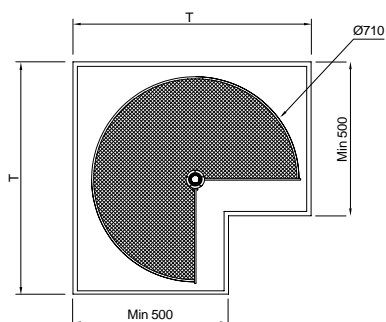

BOTELLERO EXTRAIBLE
PULL OUT BOTTLE BASKET

234 03G



234 03G 1

GA Gris Antracita
Dark Grey



SERIE	CÓDIGO	MÓDULO <small>mm</small>	x	w	h
234	03 15G	150	110	480	660
234	03 20G	200	160	480	660

- Botellero extraible multiusos
Pull out bottle basket
- Acabado: Gris antracita con base de madera y goma antideslizante
Finish: Dark grey with wood base
- Instalación apta para módulos de 150-200mm
Suitable for 150 or 200 mm cabinet size
- Equipa guías cuadro con cierre suave
Fitted with soft closing slides

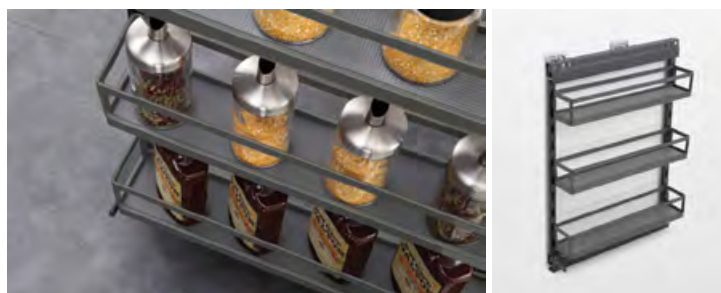
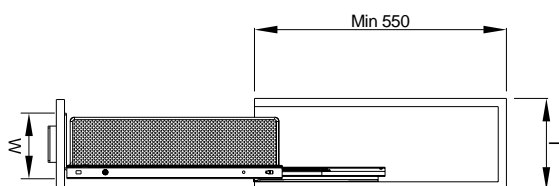

OHMYHOME



237 03G 1

GA Gris Antracita
Dark Grey

- Cesto extraible multiusos
Pull out basket
- Acabado: Gris antracita con base de madera y goma antideslizante
Finish: Dark grey with wood base
- Instalación apta para módulos desde 400-600mm
Suitable for 400mm to 600mm cabinet size
- Equipa guías cuadro con cierre suave
Fitted with undermount soft closing slides

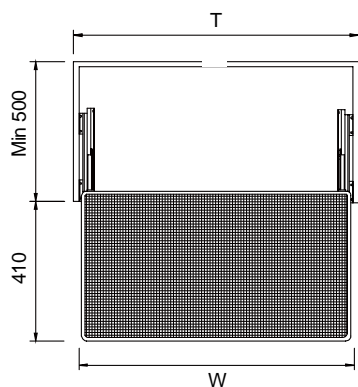

SERIE	CÓDIGO	MÓDULO	x	w	h
237	03 40G	400	365	460	180
237	03 45G	450	415	460	180
237	03 50G	500	465	460	180
237	03 60G	600	565	460	180





240 01G 1

GA Gris Antracita
Dark Grey

- Riñonero extraible
Swing tray
- Con apertura a derechas o izquierdas
Left and right installation for choice
- Acabado: Gris antracita con base de madera y goma antideslizante
Finish: Dark grey with wood base
- Instalación en módulo de 900mm
Suitable for 900mm cabinet size
- Tamaño mínimo puerta: 450 mm
Minimum door size: 450 mm

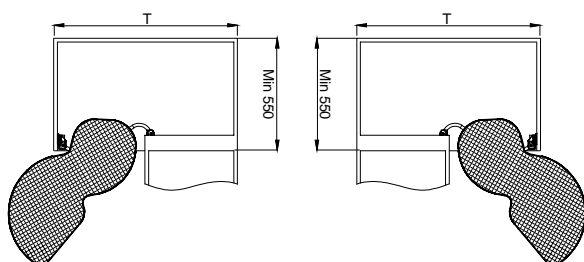

SERIE	CÓDIGO	MÓDULO (mm)	x	w	h
240	01 90DG	900	830	440	540
240	01 90IG	900	830	440	540

* D Apertura a derechas (Right opening)

I Apertura a izquierdas (Left opening)

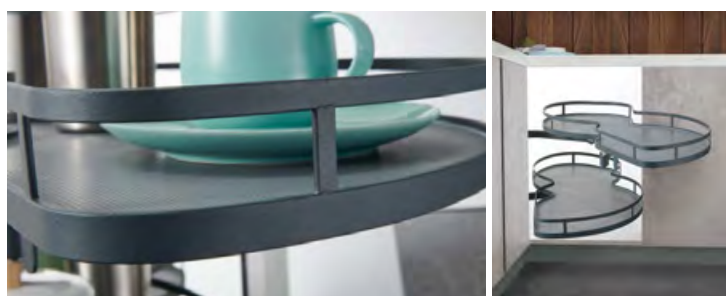

242G 1

GA Gris Antracita
Dark Grey

- Columna extraíble con 6 bandejas
Tall unit with 6 layers
- Acabado: Gris antracita con base de madera y goma antideslizante
Finish: Dark grey with wood base
- Instalación apta para módulos desde 150-450mm
Suitable for cabinet size from 150mm until 450mm
- Equipa guías cuadro con cierre suave.
Fitted with soft closing slides



SERIE	CÓDIGO	MÓDULO	x	w	h
242	15 062G	150	460	90	1850-2200
242	20 062G	200	460	140	1850-2200
242	30 062G	300	460	240	1850-2200
242	40 062G	400	460	340	1850-2200
242	45 062G	450	460	390	1850-2200





OHMY
HOME



INTERIOR ARMARIOS CLOSETS



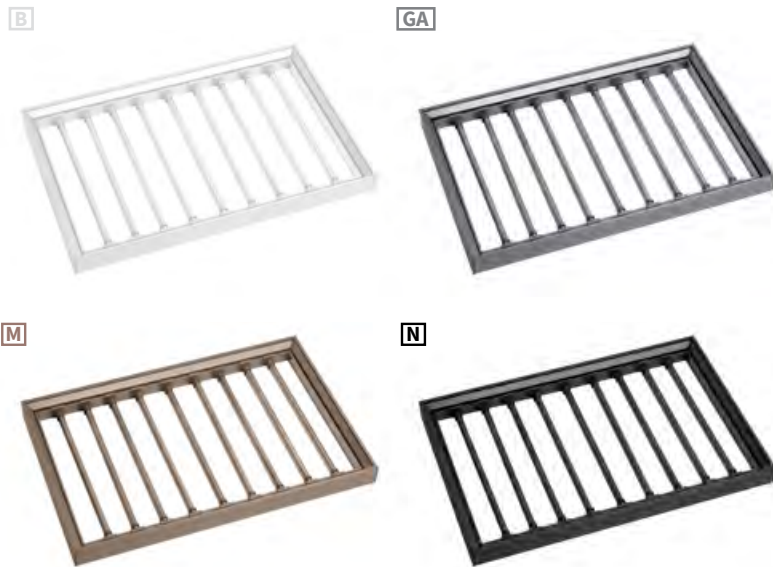

B	Blanco White	M	Marrón Brown
GA	Gris Antracita Dark Grey	N	Negro Black

- Las varillas para los pantalones son ajustables pudiendo adaptarse a las necesidades de almacenamiento. Así mismo puede aumentarse el número de varillas para así poder colocar tantas prendas como se desee.

Trousers racks can be installed in many positions. Additional hangers are also available.

SERIE	VARILLAS RACKS
250S	B 250S 00 01
	GA 250S 00 01G
	M 250S 00 01M
	N 250S 00 01N



Marco fabricado en aluminio aportando un diseño minimalista y robusto al mismo tiempo con un ajuste de +- 50mm para ajustarse a diferentes dimensiones del módulo.

Frame made of aluminium. Width can be adjusted +-50mm.

El pantalonero cuenta con una guía cuadro de extracción total, con cierre suave asegurando una apertura y cierre óptima.

The item includes a soft closing slide that allows the trouser rack to operate smoothly.

250S 10



SERIE	MODELO	MÓDULO	w	x	h
250S	B 250S 60 01	600 mm	564	460	71
	GA 250S 60 01G				
	M 250S 60 01M				
	N 250S 60 01N				
	B 250S 70 01	700 mm	664	460	71
	GA 250S 70 01G				
	M 250S 70 01M				
	N 250S 70 01N				
	B 250S 80 01	800 mm	764	460	71
	GA 250S 80 01G				
	M 250S 80 01M				
	N 250S 80 01N				
	B 250S 90 01	900 mm	864	460	71
	GA 250S 90 01G				
	M 250S 90 01M				
	N 250S 90 01N				

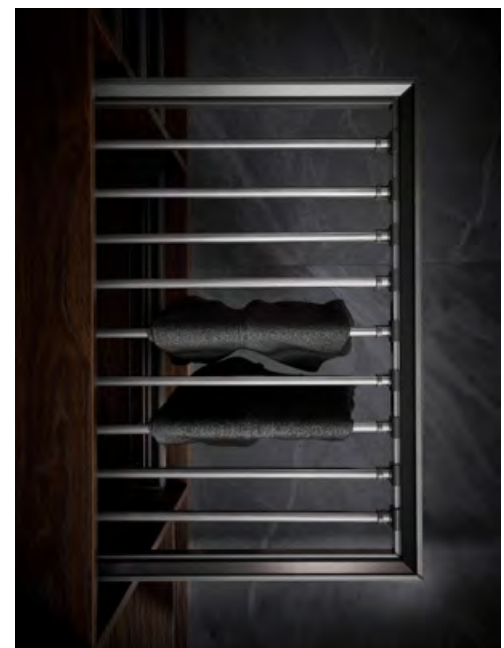



B	Blanco White	M	Marrón Brown
GA	Gris Antracita Dark Grey	N	Negro Black

250S  10

B **GA** **M** **N**

SERIE	REFERENCIA	ACABADO
250S	B 250S 00 10	Blanco/white
	GA 250S 00 10G	Gris Antracita/Dark Grey
	M 250S 00 10M	Marrón/Brown
	N 250S 00 10N	Negro/Black

Nota: Esta referencia sólo incluye el organizador.
Los pantaloneros hay que pedirlos por separado.

This item code is only for the classification box.

Trousers rack is sold separatelly.

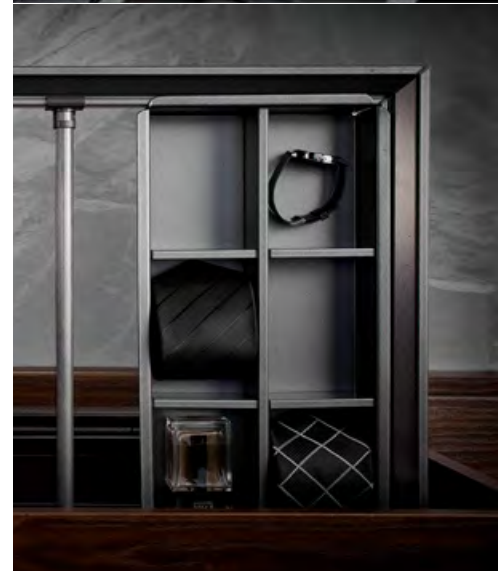

B



- Pantalonero de 10 perchas para ser instalado en el lateral del módulo.

*Soft closing trouser rack with 10 hangers.
Side mounted.*



- Cuenta con una guía cuadro de extracción total, con cierre suave asegurando una apertura y cierre óptima.

The trouser rack includes a soft closing slide that allows the item to operate smoothly.

250S 10

B **GA** **M** **N**



SERIE MODELO

w x h

250S **B** 250S 20 01
 GA 250S 20 01G
 M 250S 20 01M
 N 250S 20 01N

350x455x115mm

B Blanco White	M Marrón Brown
GA Gris Antracita Dark Grey	N Negro Black



M



- Pantalonero extraible de 10 perchas.

*Pull out trouser rack with 10 hangers.
Top mounted.*



- Cuenta con una guía cuadro de extracción total, con cierre suave asegurando una apertura y cierre óptima.

The trouser rack includes a soft closing slide that allows the item to operate smoothly.

250S 10

B **GA** **M** **N**



MÓDULO
MÍNIMO

w x h

SERIE	MODELO	MÓDULO MÍNIMO	w x h
250S	B 250S 21 01 GA 250S 21 01G M 250S 21 01M N 250S 21 01N	500 mm	350x455x115mm

B

Blanco
White

M

Marrón
Brown

GA

Gris Antracita
Dark Grey

N

Negro
Black

B



N



M



- Pantalonero doble extraible con 10 perchas.

Pull out double trouser rack with 10 hangers. Top mounted.



- Cuenta con una guía cuadro de extracción total, con cierre suave asegurando una apertura y cierre óptima.

The trouser rack includes a soft closing slide that allows the item to operate smoothly.

250S 10

B **GA** **M** **N**



SERIE	MODELO	MÓDULO MÍNIMO	w x h		
			w	x	h
250S	B 250S 22 01	700 mm	630x455x115mm		
	GA 250S 22 01G				
	M 250S 22 01M				
	N 250S 22 01N				

B Blanco White	M Marrón Brown
GA Gris Antracita Dark Grey	N Negro Black





GA

- Marco fabricado en aluminio aportando un diseño minimalista y robusto al mismo tiempo con un ajuste de + 50mm para ajustarse a diferentes dimensiones del módulo.

*Frame made of alluminium.
Width can be adjusted +50mm.*



- El cesto extraible cuenta con una guía cuadro de extracción total, con cierre suave asegurando una apertura y cierre óptima.

The Pull out rack includes a soft closing slide that allows the trouser rack to operate smoothly.

253S 10

B **GA** **M** **N**



B Blanco
White

M Marrón
Brown

GA Gris Antracita
Dark Grey

N Negro
Black

SERIE	MODELO	MÓDULO	w	x	h
253S	B 253S 60 01	600 mm	564	460	71mm
	GA 253S 60 01G				
	M 253S 60 01M				
	N 253S 60 01N				
	B 253S 70 01	700 mm	664	460	71mm
	GA 253S 70 01G				
	M 253S 70 01M				
	N 253S 70 01N				
	B 253S 80 01	800 mm	764	460	71mm
	GA 253S 80 01G				
	M 253S 80 01M				
	N 253S 80 01N				
	B 253S 90 01	900 mm	864	460	71mm
	GA 253S 90 01G				
	M 253S 90 01M				
	N 253S 90 01N				



N



- Marco fabricado en aluminio aportando un diseño minimalista y robusto al mismo tiempo con un ajuste de $\pm 50\text{mm}$ para ajustarse a diferentes dimensiones del módulo.

*Frame made of alluminium.
Width can be adjusted $\pm 50\text{mm}$.*



- El zapatero cuenta con una guía cuadro de extracción total, con cierre suave asegurando una apertura y cierre óptima.

The shoe rack includes a soft closing slide that allows the trouser rack to operate smoothly.

251S 10

B **GA** **M** **N**



SERIE	MODELO	MÓDULO	w	x	h
251S	B 251S 60 01	600 mm	564	460	71
	GA 251S 60 01G				
	M 251S 60 01M				
	N 251S 60 01N				
	B 251S 70 01	700 mm	664	460	71
	GA 251S 70 01G				
	M 251S 70 01M				
	N 251S 70 01N				
	B 251S 80 01	800 mm	764	460	71
	GA 251S 80 01G				
	M 251S 80 01M				
	N 251S 80 01N				
	B 251S 90 01	900 mm	864	460	71
	GA 251S 90 01G				
	M 251S 90 01M				
	N 251S 90 01N				





GA



M



255S



..... 1

B **GA** **M** **N**



MÓDULO
MÍNIMO

w x h

SERIE	MODELO	MÓDULO MÍNIMO	w x h
255S	B 255S 01 01	500 mm	115x455x115mm
	GA 255S 01 01G		
	M 255S 01 01M		
	N 255S 01 01N		



- Cuenta con una guía cuadro de extracción total, con cierre suave asegurando una apertura y cierre óptima.

The pull out hanger includes a soft closing slide that allows the item to operate smoothly.

B Blanco White	M Marrón Brown
GA Gris Antracita Dark Grey	N Negro Black





B BLANCO *WHITE*



GA GRIS ANTRACITA *DARK GREY*



P GRIS PLATA *SILVER GREY*



N NEGRO *BLACK*



M MARRÓN *BROWN*



252  10

B **GA** **M** **N** **P**



SERIE	MODELO	w	x	h
252	B 252 01 01	3000×12×30mm		
	GA 252 01 01G			
	M 252 01 01M			
	N 252 01 01N			
	P 252 01 01P			

JUEGO DE SOPORTES
PARA BARRA MINIMALISTA
SIDE SUPPORT

252



• Unidad mínima de venta: 2 unidades

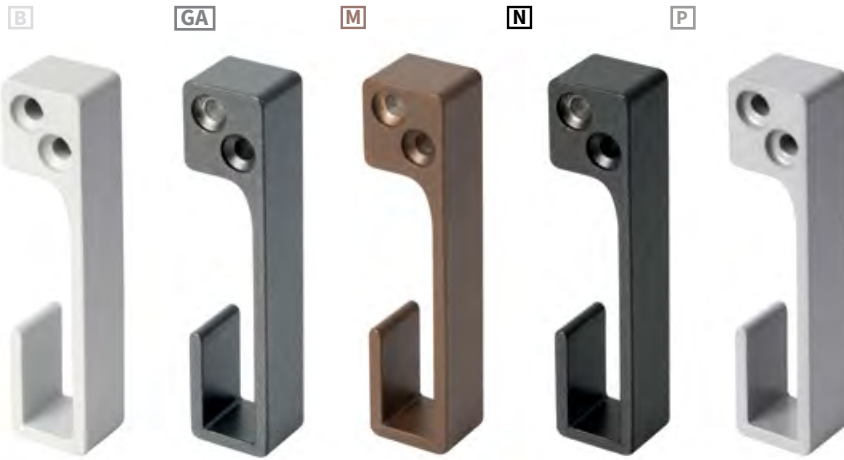

252 ¹⁰



SERIE MODELO

SERIE	MODELO
252	B 252 04 01
	GA 252 04 01G
	M 252 04 01M
	N 252 04 01N
	P 252 04 01P



SOPORTE CENTRAL
PARA BARRA MINIMALISTA
CENTRAL SUPPORT

252



252 ¹⁰



SERIE MODELO

SERIE	MODELO
252	B 252 05 01
	GA 252 05 01G
	M 252 05 01M
	N 252 05 01N
	P 252 05 01P

CORBATERO EXTRAIBLE
TIE RACK

252



252 10

GA



MODELO	MÓDULO MÍNIMO	w	x	h
GA 252 10 02	200 mm	115	455	115

PERCHERO ABATIBLE
WARDROBE LIFTER

256



256 1.....6

B GA M N P

SERIE	MODELO	TAMAÑO	PESO SOPORTADO
256	B 256 45 01	450-600 mm	12 KG
	GA 256 45 01G		
	M 256 45 01M		
	N 256 45 01N		
	P 256 45 01P		
	B 256 60 01	600-830 mm	12 KG
	GA 256 60 01G		
	M 256 60 01M		
	N 256 60 01N		
	P 256 60 01P		
	B 256 83 01	830-1150 mm	12 KG
	GA 256 83 01G		
	M 256 83 01M		
	N 256 83 01N		
	P 256 83 01P		

- Perchero abatible con doble freno, tanto en la subida como en la bajada del perchero.
Wardrobe lifter with double buffer system that allows the item to work smoothly upwards and downwards.



MANIVELAS

Door handles

306-308 AINARA



329-331 HERA



309-311 XIANA



332-334 TERRA



312-314 KEIRA



335-339 AURA



315-317 TALIA



342-344 ADARA



318-320 ATENEA



346-347 ISIS



321-323 ETNA



348-349 IRIS



324-328 SAGA



350-352 MINERVA



MANILLONES

Pull handles

340-341 AURA



345 ADARA



353-355 MINERVA



COMPLEMENTOS

Accessories

356-361





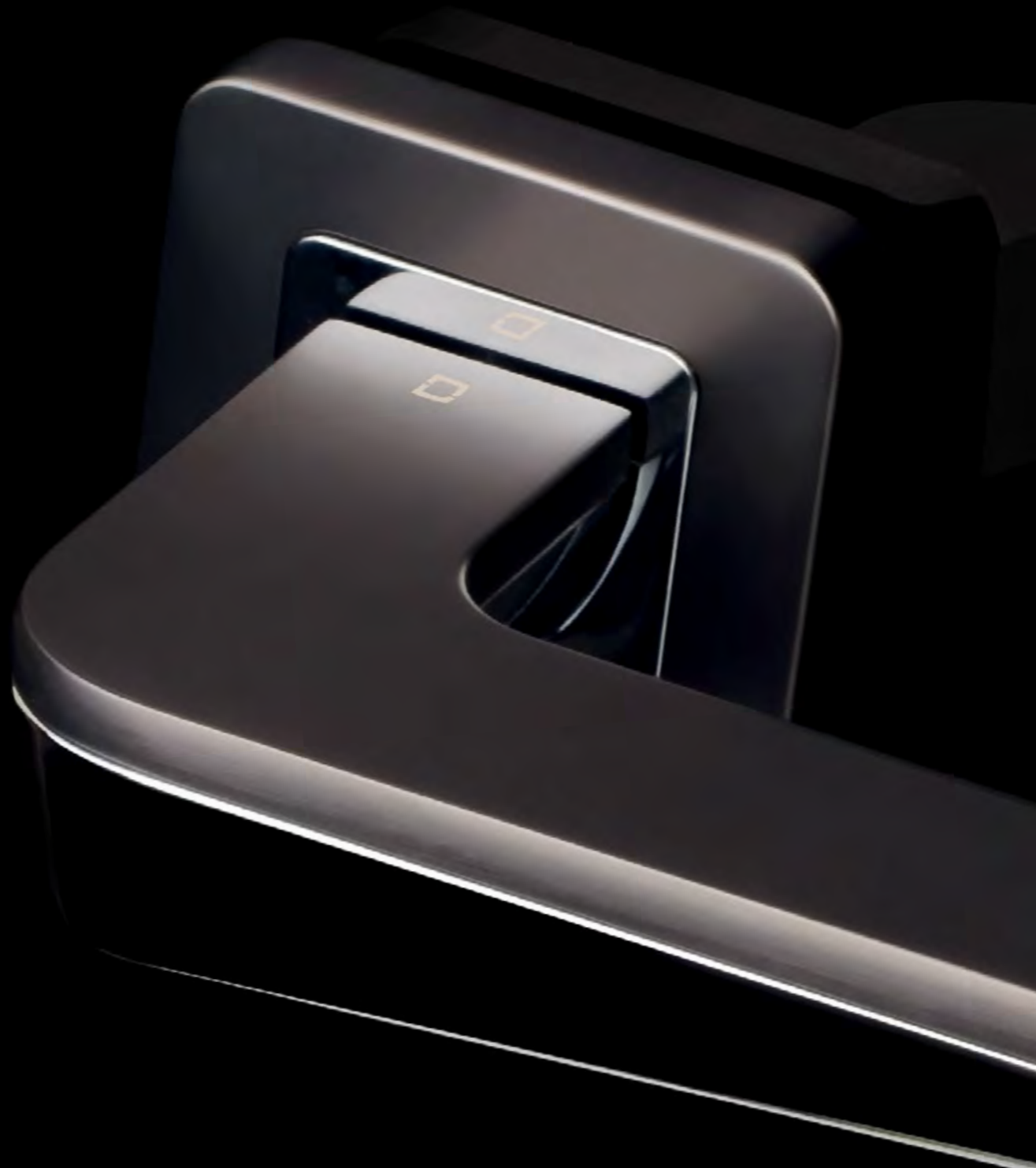



OHMY
DOOR



AINARA



Manivela con roseta tipo "slim"
Door handle on slim rose

AINARA



7701.....20

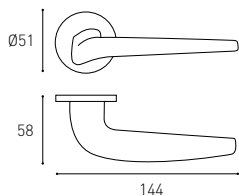

PVD 770.80.08



NS 770.80.01



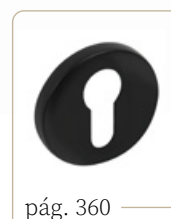

N 770.80.07



Manivela con placa
Door handle on plate

AINARA



770  
.....1.....20

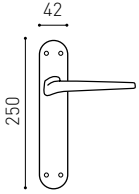

PVD



770.01.08

NS



770.01.01

 770.01.07

XIANA



Manivela con roseta tipo "slim"
Door handle on slim rose

XIANA



7711.....20

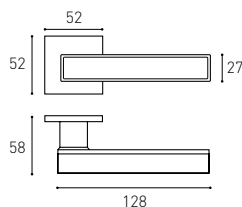

N 771.90.07B



P 771.90.12N





pág. 361

Manivela con placa
Door handle on plate

XIANA



771  
.....1.....20

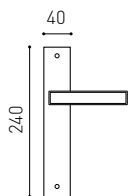

771.10.07B

 771.10.12N



Manivela con roseta tipo "slim"
Door handle on slim rose

KEIRA



6721.....20

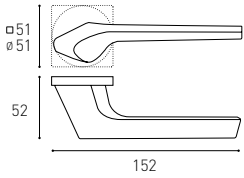

N 672.80.07



NS 672.80.01



N 672.90.07



NS 672.90.01

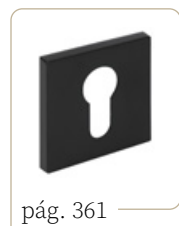

Manivela con placa
Door handle on plate

KEIRA



672  
.....1.....20

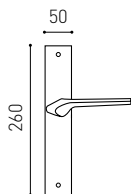

NS



672.10G.01

 672.10G.07

TALIA



OHMYDOOR

TALIA



Manivela con roseta
Door handle on rose

754  
.....1.....20

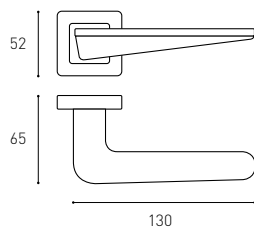

CRT 754.60.15





pág. 356

Manivela con placa
Door handle on plate

TALIA



754  
.....1.....20

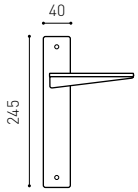

754.10.15T

 754.10.15

ATENEA



Manivela con roseta
Door handle on rose

ATENEA



7531.....20

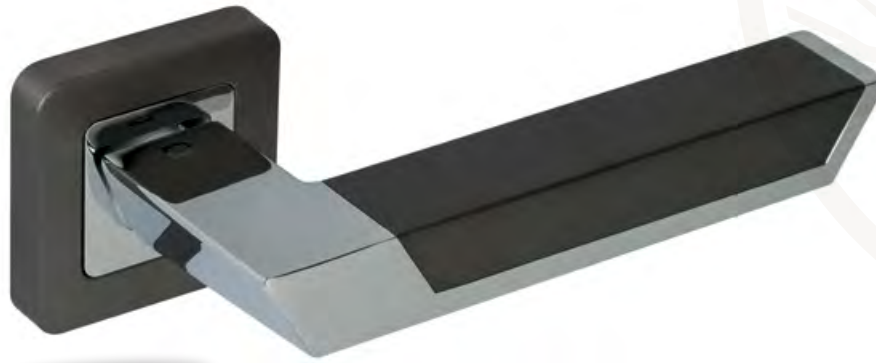
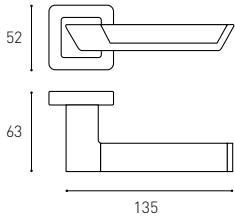

CRT 753.60.15

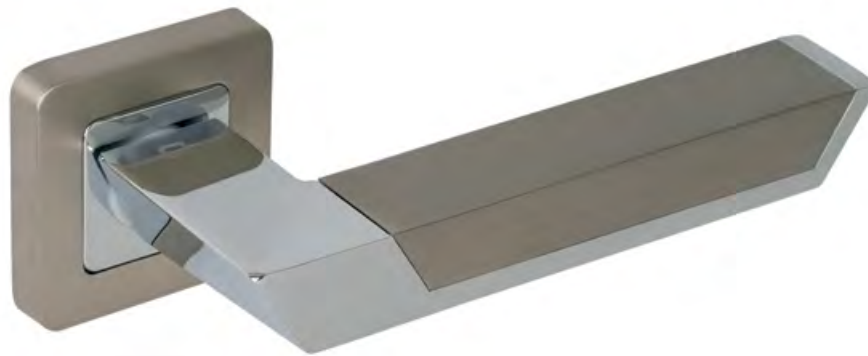

CRP 753.60.12



pág. 356

Manivela con placa
Door handle on plate

ATENEA



7531.....20

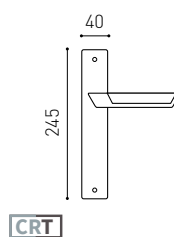
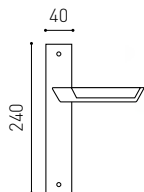

753.10.15

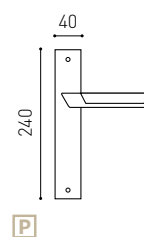

753.10.12

T 753.10.15T

ETNA



Manivela con roseta
Door handle on rose

ETNA



7521.....20

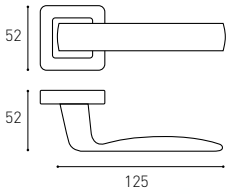

NS 752.60.01

N



752.60.07



pág. 356

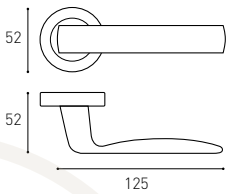

N 752.50.07





pág. 358

Manivela con placa
Door handle on plate

ETNA



752  
.....1.....20

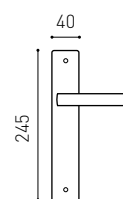
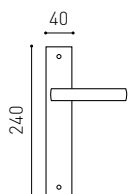

NS



752.10.01

 752.10.07



SAGA

Manivela con roseta
Door handle on rose

757  
.....1.....20

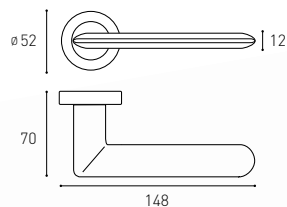

NS 757.50.01

CR



757.50.04

N



757.50.07

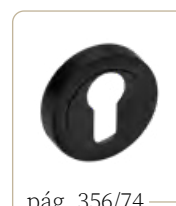

pág. 356/74

SAGA

Manivela con roseta
Door handle on rose

757  
.....1.....20

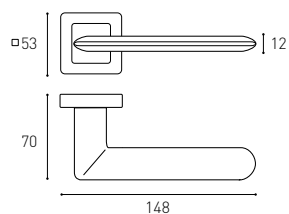

NS 757.60.01



757.60.04



757.60.07



pág. 356

Manivela con placa
Door handle on plate

SAGA



757  
.....1.....20

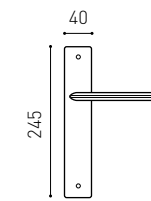
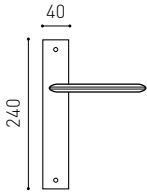

NS



757.10.01

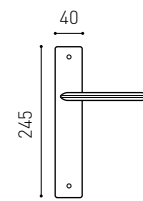

CR



757.10.04

 757.10.07

Manivela con placa
Door handle on plate

SAGA



7571.....20

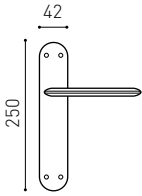

NS



757.01.01

CR



757.01.04

757.01.07

HERA



HERA



Manivela con roseta
Door handle on rose

7561.....20

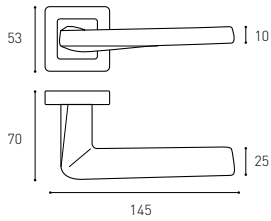

756.60.12

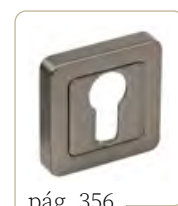



pág. 356

Manivela con placa
Door handle on plate

HERA



756  
.....1.....20

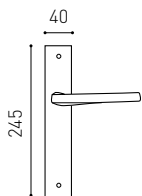

 756.10.12

TERRA



TERRA

Manivela con roseta
Door handle on rose

7511.....20

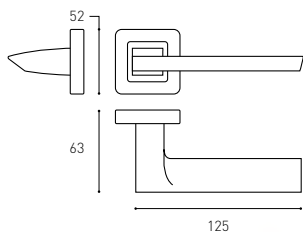

CR 751.60.04



NS 751.60.01





pág. 356

Manivela con placa
Door handle on plate

TERRA



751  
.....1.....20

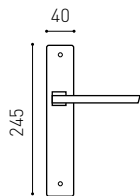

751.10.04

 751.10.01

AURA



Manivela con roseta
Door handle on rose

AURA



7581.....20

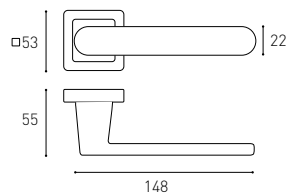

B 758.60.13

N



758.60.07

NS



758.60.01



pág. 356

Manivela con roseta
Door handle on rose

AURA



7581.....20

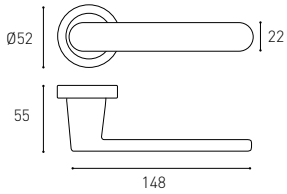

N 758.50.07



758.50.13

NS



758.50.01





pág. 358/74

Manivela con placa
Door handle on plate

AURA



758  
.....1.....20

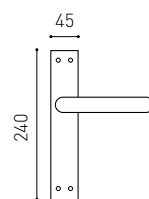
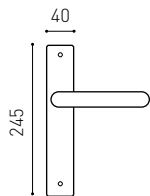



758.11.13

 758.10.01

Manivela con placa
Door handle on plate

AURA



758  
.....1.....20

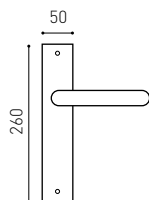

758.10G.13



758.10G.01

 758.10G.07

Manillón
Pull handle on roses

AURA



758  
.....2.....40

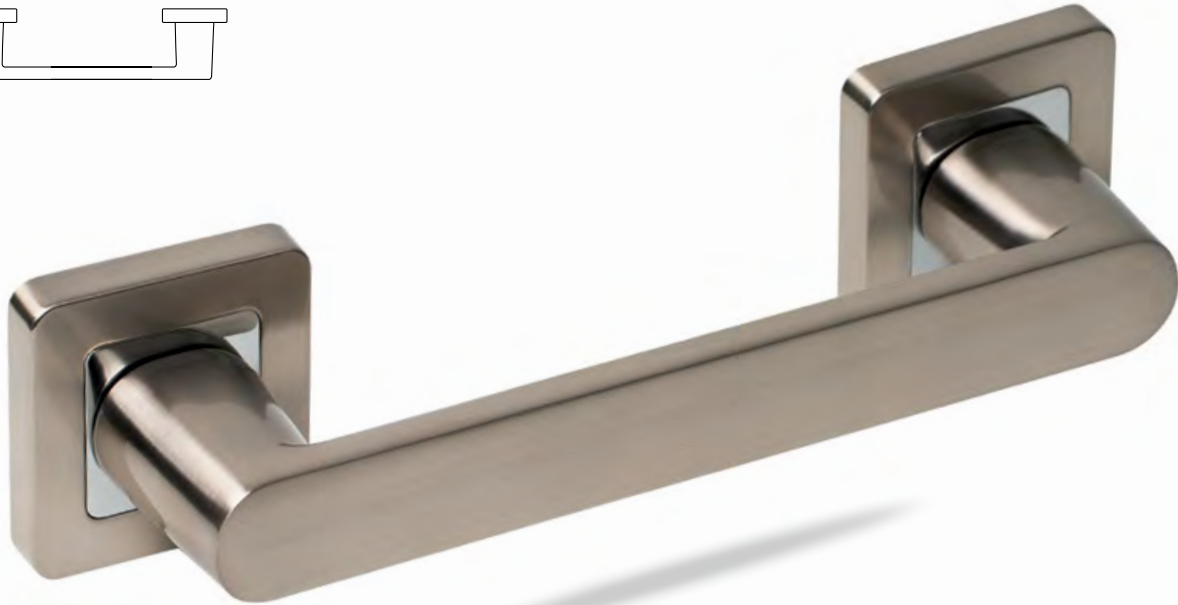
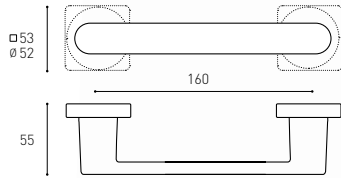

NS 758.66.01



758.66.07



758.55.07



758.66.13



758.55.13





758.55.01

Manillón con placa
Pull handle on plate

AURA



758  
.....2.....40

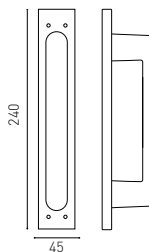
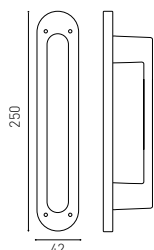

 758.05.07



 758.25.07

NS



758.25.01



Manivela con roseta
Door handle on rose

ADARA



7501.....20

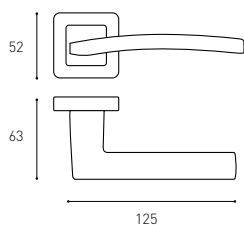

T 750.60.15T



750.60.15



750.60.12



750.60.01



pág. 356

Manivela con placa
Door handle on plate

ADARA



750  
.....1.....20

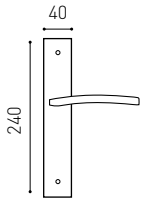

T 750.10.15T

Manillón
Pull handle on roses

ADARA



750  
.....2.....40

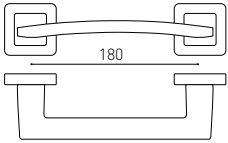

P 750.66.12

N



750.66.07

T



750.66.15

NS



750.66.01

T



750.66.15T

Manivela con roseta Door handle on rose

7551.....20

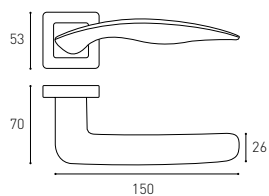

NS 755.60.01



pág. 356

Manivela con placa
Door handle on plate

ISIS



755  
.....1.....20

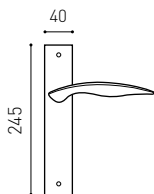

 755.10.01

IRIS

Manivela con roseta
Door handle on rose

7601.....20

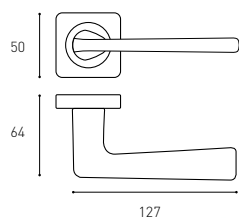

NNS 760.60.11



pág. 359



NNS 760.50.11



pág. 74

Manivela con placa
Door handle on plate

IRIS



760  
.....1.....20

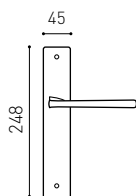

NNS 760.41.11

Manivela con roseta
Door handle on rose

MINERVA



7611.....20

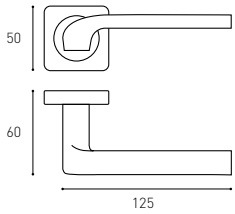

SAT 761.60.02

CR



761.60.04

NNS



761.60.11



pág. 359

Manivela con roseta
Door handle on rose

MINERVA



7611.....20

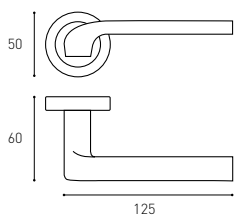

CR 761.50.04



761.50.01



761.50.02



pág. 74

Manivela con placa
Door handle on plate

MINERVA



7611.....20

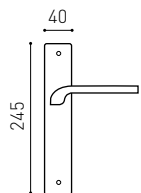

NNS



761.10.11

CR 761.10.04

Manillón con placa
Pull handle on plate

MINERVA



7611.....20



CR





761.20.04

NNS 761.20.01

Manillón con roseta
Pull handle on roses

MINERVA



751  
.....2.....40

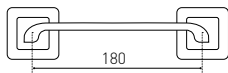

T 751.66.15

NS



751.66.01

CR



751.66.04

Manillón con roseta
Pull handle on roses

MINERVA



761  
.....2.....40

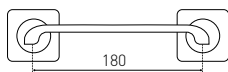

NNS 761.66.11

CR



761.66.04

SAT



761.66.02



Roseta cuadrada con bocallave tipo "A"
 Square escutcheon with keyhole "A"

750.61

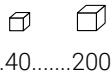

.....40.....200

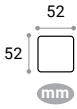

CNS 750.61.14

CR



750.61.04

P



750.61.12

B



750.61.13

N



750.61.07

CRT



750.61.15

T



750.61.15T

CRP



753.61.12

Roseta cuadrada con bocallave tipo "B"
 Square escutcheon with keyhole "B"

750.62



.....40.....200

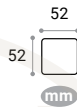

CNS 750.62.14

CR



750.62.04

P



750.62.12

B



750.62.13

N



750.62.07

CRT



750.62.15

CRP



753.62.12

Juego condena y emergencia con roseta cuadrada
Turn and release knob on square roses

750.63  
.....10.....50

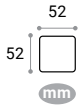

CNS 750.63.14

CR



750.63.04

P



750.63.12

B



750.63.13

N



750.63.07

CRT



750.63.15

T



750.63.15T

CRP



753.63.12

■ ■ ■
Roseta con bocallave tipo "A"

Escutcheon with keyhole "A"

750.5120.....400



N 750.51.07

758.5120.....400



B 758.51.13

Roseta con bocallave tipo "B"

Escutcheon with keyhole "B"

750.5220.....400



N 750.52.07

758.5220.....400



B 758.52.13

Juego condena y emergencia con roseta

Turn and release knob on roses

750.534.....80



N 750.53.07

758.534.....80



B 758.53.13

■ ■ ■
Roseta cuadrada con bocallave tipo "A"
 Square escutcheon with keyhole "A"

760.6120.....400

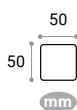

NNS 760.61.11

SAT

CR



760.61.02



760.61.04

Roseta cuadrada con bocallave tipo "B"
 Square escutcheon with keyhole "B"

760.6220.....400

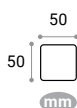

NNS 760.62.11

CR



760.62.04

Juego condena y emergencia con roseta cuadrada
 Turn and release knob on square roses

760.634.....80

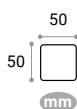

NNS 760.63.11

CR



760.63.04

SAT



760.63.02



Roseta tipo "slim" con bocallave tipo "A"

Slim escutcheon with keyhole "A"

770.81

.....20.....400



N 770.81.07

NS



770.81.01

PVD



770.81.08

Juego condena y emergencia con roseta tipo "slim"

Turn and release knob on slim roses

770.83

.....4.....80



N 770.83.07

NS



770.83.01

PVD



770.83.08



Roseta cuadrada tipo "slim" con bocallave tipo "A"

Slim square escutcheon with keyhole "A"

770.91

.....20.....400

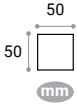

N 770.91.07

NS



770.91.01

P



770.91.12

Juego condena y emergencia con roseta cuadrada tipo "slim"

Turn and release knob on slim square roses

770.93

.....4.....80

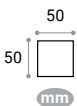

N 770.93.07

NS



770.93.01

P



770.93.12

MANIVELAS Y COMPLEMENTOS 2022



 C/ Río Sil N°8
Polígono Industrial Trevenez
29196 MÁLAGA

 TFNO 952 33 61 65

 ferremian@telefonica.net

 www.ferremian.es

